

Quality and Support

Secure pad-log-position

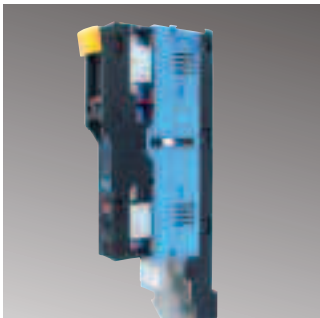

NH Fuse-Switches, vertical design, series R2000



NH Fuse-Switches, vertical design, series NTSL



NH Fuse-Switch, vertical design, size 4a, 1-pole switching

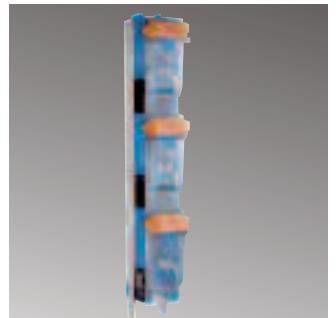

Content

NH Fuse-Switches, vertical design, 1-pole or 3-pole switching	160
NH Fuse-Rails	164
Accessories	166
Technical data	see page 168



System

EFEN with its long tradition as a producer of NH Fuse-Switches, vertical design, offers ideal solutions for different applications such as power distribution or the industry. Four different series offer many options.

The NTSL series offers a mature technology which is characterised through a product with high thermic and mechanical qualities. The R2000 series fulfils all specification for industrial applications. EKDEO and the NH Fuse-Rail, EDURO, are particularly designed for the requirements of the power utility companies.

Features

All insulating parts are made of halogen-free, flame retardant polymers with excellent temperature performance. Due to a wide range of accessories mounting under voltage is possible.

Series EDURO and EKDEO



non-contact unlocking
of the the Fuse-Link



All Types

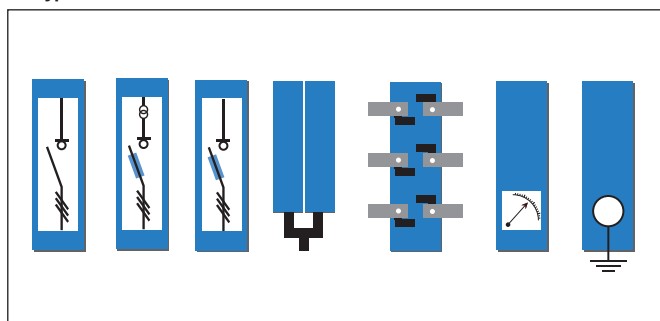

NH Fuse-Switches, vertical design

 For more information
see page **168**

38500-0000

NH Fuse-Switches, vertical design, size 00-3, 3-pole switching, terminal top/bottom selection

Description	Size	Amps	Order-No.	PU	PG	Sur. Ag	Sur. Cu	Price €/pc.
Pressure plate for 1,5 - 50 mm ²	00N	125	38501-0000	2	NSL 3	0,010	0,054	93,00
Multiple use terminal (screw M8) Directmounting on 60 mm busbar systems with hooks	00IN	160	38534-1000	2	NSL 00IN	0,013	0,087	57,50
Multiple use terminal (screw M8) Directmounting on 60 mm busbar systems with hooks	00IN	160	38534-5000	2	NSL 00IN	0,013	0,087	57,50
Multiple use terminal (screw M8)	00IN	160	38544-0000	2	NSL 00IN	0,013	0,070	52,50
Flat terminal M8	00N	160	38500-0000	2	NSL 3	0,010	0,054	91,00
Pressure plate with contact prism for 2,5 - 70 mm ²	00N	160	38502-0000	2	NSL 3	0,010	0,054	96,00
Threaded bolt M12 x 30	R2000 1	250	38612-0020	1	NSL 2	0,039	0,233	237,00
Inserted screw nut M12	R2000 1	250	38614-0020	1	NSL 2	0,039	0,233	237,00
V-stamped (Clamps not attached)	R2000 1	250	38615-0020	1	NSL 2	0,039	0,234	237,00
Threaded bolt M12 x 30	R2000 2	400	38622-0020	1	NSL 2	0,039	0,233	242,00
Inserted screw nut M12	R2000 2	400	38624-0020	1	NSL 2	0,039	0,233	242,00
V-stamped (Clamps not attached)	R2000 2	400	38625-0020	1	NSL 2	0,039	0,234	242,00
Threaded bolt M12 x 30	R2000 3	630	38632-0020	1	NSL 2	0,039	0,258	278,00
Inserted screw nut M12	R2000 3	630	38634-0020	1	NSL 2	0,039	0,258	278,00
V-stamped (Clamps not attached)	R2000 3	630	38635-0020	1	NSL 2	0,039	0,258	278,00



38614-1240

NH Fuse-Switches, vertical design, size 1-3, 3-pole switching, series R2000, with mounting hooks

Description	Size	Amps	Order-No.	PU	PG	Sur. Ag	Sur. Cu	Price €/pc.
Threaded bolt M12x30	1	250	38612-1240	1	NSL 2	0,039	0,233	254,00
Inserted screw nut M12	1	250	38614-1240	1	NSL 2	0,039	0,233	254,00
V-stamped (Clamps not attached)	1	250	38615-1240	1	NSL 2	0,039	0,233	254,00
Threaded bolt M12x30	2	400	38622-1240	1	NSL 2	0,039	0,233	259,00
Inserted screw nut M12	2	400	38624-1240	1	NSL 2	0,039	0,233	259,00
V-stamped (Clamps not attached)	2	400	38625-1240	1	NSL 2	0,039	0,233	259,00
Threaded bolt M12x30	3	630	38632-1240	1	NSL 2	0,039		285,00
Inserted screw nut M12	3	630	38634-1240	1	NSL 2	0,039	0,258	293,00
V-stamped (Clamps not attached)	3	630	38635-1240	1	NSL 2	0,039	0,258	293,00

NH Fuse-Switches, vertical design

 For more information
see page 168

38520-0000

NH Fuse-Switches, vertical design, size 00-4a, 1-pole switching, terminal top or bottom selection

Description	Size	Amps	Order-No.	PU	PG	Sur. Ag	Sur. Cu	Price €/pc.
For 185 mm ² busbar systems, Multiple use terminal (screw M8)	00N	160	38520-0000	2	NSL 3	0,012	0,071	121,00
For 185 mm ² busbar systems, V-clamps 25 - 30 mm ²	00N	160	38525-0600	2	NSL 3	0,012	0,105	167,00
Threaded bolt M12 x 30	R2000 1	250	38612-0000	1	NSL 2	0,039	0,233	237,00
Inserted screw nut M12	R2000 1	250	38614-0000	1	NSL 2	0,039	0,233	237,00
V-stamped (Clamps not attached)	R2000 1	250	38615-0000	1	NSL 2	0,039	0,233	237,00
Threaded bolt M12 x 30	R2000 2	400	38622-0000	1	NSL 2	0,039	0,233	242,00
Inserted screw nut M12	R2000 2	400	38624-0000	1	NSL 2	0,039	0,233	242,00
V-stamped (Clamps not attached)	R2000 2	400	38625-0000	1	NSL 2	0,039	0,234	242,00
Threaded bolt M12 x 30	R2000 3	630	38632-0000	1	NSL 2	0,039	0,258	278,00
Inserted screw nut M12	R2000 3	630	38634-0000	1	NSL 2	0,039	0,258	278,00
V-stamped (Clamps not attached)	R2000 3	630	38635-0000	1	NSL 2	0,039	0,258	278,00
Flat terminal M16, terminal bottom	4a	1250	38400-0000	1	NSL 3	0,133	1,12	774,00
Flat terminal M16, terminal top	4a	1250	38450-0000	1	NSL 3	0,133	1,12	774,00
Flat terminal 2xM12, terminal bottom	4a	1600	38400-0020	1	NSL 3	0,133	1,134	1.020,00
Flat terminal 2xM12, terminal top	4a	1600	38450-0020	1	NSL 3	0,133	1,134	1.020,00



38614-1230

NH Fuse-Switches, vertical design, size 1-3, 1-pole switching, series R2000, with mounting hooks

Description	Size	Amps	Order-No.	PU	PG	Sur. Ag	Sur. Cu	Price €/pc.
Threaded bolt M12x30	1	250	38612-1230	1	NSL 2	0,039	0,233	254,00
Inserted screw nut M12	1	250	38614-1230	1	NSL 2	0,039	0,233	254,00
V-stamped (Clamps not attached)	1	250	38615-1230	1	NSL 2	0,039	0,233	254,00
Threaded bolt M12x30	2	400	38622-1230	1	NSL 2	0,039	0,233	261,00
Inserted screw nut M12	2	400	38624-1230	1	NSL 2	0,039	0,233	261,00
V-stamped (Clamps not attached)	2	400	38625-1230	1	NSL 2	0,039	0,233	261,00
Threaded bolt M12x30	3	630	38632-1230	1	NSL 2	0,039	0,258	293,00
Inserted screw nut M12	3	630	38634-1230	1	NSL 2	0,039	0,258	293,00
V-stamped (Clamps not attached)	3	630	38635-1230	1	NSL 2	0,039	0,258	293,00

NH Fuse-Switches, vertical design

For more information
see page **168**



38624-0170

NH Fuse-Switches, vertical design, size 1-3, 1-pole or 3-pole switching, Series R2000 for horizontal mounting

Description	Size	Amps	Order-No.	PU	PG	Sur. Ag	Sur. Cu	Price €/pc.
Inserted screw nut M12, 3-pole switching	1	250	38614-0170	1	NSL 2	0,039	0,233	255,00
Inserted screw nut M12, 1-pole switching	1	250	38614-0180	1	NSL 2	0,039	0,233	255,00
Inserted screw nut M12, 3-pole switching	2	400	38624-0170	1	NSL 2	0,039	0,233	261,00
Inserted screw nut M12, 1-pole switching	2	400	38624-0180	1	NSL 2	0,039	0,233	261,00
Inserted screw nut M12, 3-pole switching	3	630	38634-0170	1	NSL 2	0,039	0,233	296,00
Inserted screw nut M12, 1-pole switching	3	630	38634-0180	1	NSL 2	0,039	0,233	296,00



38620-0120

NH Fuse-Switches, vertical design, size 1-3, 1-pole or 3-pole switching, Series R2000 with sidewise back connection

Properties:

- Sidewise back connection

Description	Size	Amps	Order-No.	PU	PG	Sur. Ag	Sur. Cu	Price €/pc.
side connection M12 left or right, 1-pole switching	2	400	38620-0120	1	NSL 2	0,039	0,171	268,00
side connection M12 left or right, 3-pole switching	2	400	38620-0130	1	NSL 2	0,039	0,171	271,00
side connection M12 left or right, 1-pole switching	3	630	38630-0120	1	NSL 2	0,039	0,171	301,00
side connection M12 left or right, 3-pole switching	3	630	38630-0130	1	NSL 2	0,039	0,171	344,00

NH Fuse-Switches, vertical design, size 1-3, 1-pole or 3-pole switching, Series R2000 with coupling system to connect two busbar systems of 185 mm centre distance.

Description	Size	Amps	Order-No.	PU	PG	Sur. Ag	Sur. Cu	Price €/pc.
NH-Fuse-switch, 3-pole switching as coupling unit, terminal left front of the busbar	3	630	38630-0560	1	NSL 2	0,039	0,275	473,00
NH-Fuse-switch, 3-pole switching as coupling unit, terminal left behind of the busbar	3	630	38630-0590	1	NSL 2	0,039	0,275	473,00
NH-Fuse-switch, 1-pole switching as coupling unit, terminal left front of the busbar	4a	1250	38400-0260	1	NSL 3	0,980	1,134	878,00

NH Fuse-Switches, vertical design

 For more information
see page **168**

38634-0250

NH Fuse-Switches, vertical design, 1000 A Incoming switch, Series 2000

Description	Size	Amps	Order-No.	PU	PG	Sur. Ag	Sur. Cu	Price €/pc.
M12, sidewise branch connection, 1-pole switching	3	1000	38630-0140	1	NSL 2	0,039	0,183	345,00
M12, sidewise branch connection, 3-pole switching	3	1000	38630-0150	1	NSL 2	0,039	0,183	349,00
M12, terminal back side, 1-pole switching	3	1000	38630-0530	1	NSL 2	0,039	0,183	on demand
M12, terminal back side, 3-pole switching	3	1000	38630-0540	1	NSL 2	0,039	0,183	345,00
Inserted screw nut M12, top / bottom, 3-pole switching	3	1000	38634-0250	1	NSL 2	0,056	0,310	317,00
Inserted screw nut M12, top / bottom, 1-pole switching	3	1000	38634-0260	1	NSL 2	0,056	0,310	371,00



38300-1235

NH Fuse-Switch, vertical design, size 3, 1-pole or 3-pole switching, series NTSL for 630 kVA

Description	Size	Amps	Order-No.	PU	PG	Sur. Ag	Sur. Cu	Price €/pc.
Flat terminal M12, 1-pole switching, terminal bottom	3	630kVA	38300-1235	1	NSL 2	0,063	0,317	474,00
Flat terminal M10, 3-pole switching, terminal bottom	3	630kVA	38300-1275	1	NSL 2	0,063	0,366	489,00
Flat terminal M12, 1-pole switching, terminal top	3	630kVA	38350-1235	1	NSL 2	0,072	0,317	474,00
Flat terminal M10, 3-pole switching, terminal top	3	630kVA	38350-1275	1	NSL 2	0,072	0,317	488,00
Special terminal for busbar 60mm, 3-pole switching, terminal top	3	630kVA	38350-1595	1	NSL 2	0,110	0,720	772,00
Flat terminal M12, 1-pole switching, terminal back side	3	630kVA	38374-1465	1	NSL 2	0,090	0,378	440,00
Flat terminal M12, 3-pole switching, terminal back side	3	630kVA	38374-1495	1	NSL 2	0,090	0,378	485,00

NSL/NL



38662-0000

NH Fuse-Switches - vertical design - Size 2: 400 A - series EKDEO

Description	Size	Amps	Order-No.	PU	PG	Sur. Ag	Sur. Cu	Price €/pc.
Threaded bolt M12 x 30	2	400	38662-0000	1	NSL 2	0,018	0,160	242,00
Inserted screw nut M12	2	400	38664-0000	1	NSL 2	0,018	0,160	242,00
V-stamped (Clamps not attached)	2	400	38665-0000	1	NSL 2	0,018	0,164	242,00
V2N-stamped (Clamps not attached)	2	400	38665-0470	1	NSL 2	0,018	0,164	242,00

NH Fuse-Switches, vertical design and NH Fuse-Rails

 For more information
see page 168

38200-0025

NH Fuse-Switches, vertical design, size 1-3, 1-pole or 3-pole switching, Series NTSL

Description	Size	Amps	Order-No.	PU	PG	Sur. Ag	Sur. Cu	Price €/pc.
Flat terminal M10, 1-pole switching, terminal bottom	1	250	38100-0005	1	NSL 2	0,070	0,261	209,00
Flat terminal M10, 3-pole switching, terminal bottom	1	250	38100-0025	1	NSL 2	0,070	0,261	213,00
Flat terminal M10, 1-pole switching, terminal top	1	250	38150-0005	1	NSL 2	0,070	0,261	209,00
Flat terminal M10, 3-pole switching, terminal top	1	250	38150-0025	1	NSL 2	0,070	0,261	213,00
Flat terminal M10, 1-pole switching, terminal bottom	2	400	38200-0005	1	NSL 2	0,070	0,261	217,00
Flat terminal M10, 3-pole switching, terminal bottom	2	400	38200-0025	1	NSL 2	0,070	0,261	220,50
Flat terminal M10, 1-pole switching, terminal top	2	400	38250-0005	1	NSL 2	0,070	0,261	217,00
Flat terminal M10, 3-pole switching, terminal top	2	400	38250-0025	1	NSL 2	0,070	0,261	220,00
Flat terminal M12, 1-pole switching, terminal bottom	2	630	38300-0005	1	NSL 2	0,072	0,317	251,00
Flat terminal M12, 3-pole switching, terminal bottom	3	630	38300-0025	1	NSL 2	0,072	0,317	255,00
Flat terminal M12, 1-pole switching, terminal top	3	630	38350-0005	1	NSL 2	0,072	0,317	251,00
Flat terminal M10, 3-pole switching, terminal top	3	630	38350-0025	1	NSL 2	0,072	0,317	255,00



38550-0020

NH Fuse-Rails, size 00-3, with contact and terminal cover

Description	Type	Amps	Order-No.	PU	PG	Sur. Ag	Sur. Cu	Price €/pc.
With terminal and contact cover, multiple use terminal (screw M8)	00	160	38550-0020	10	42	0,005	0,017	47,00
With terminal and contact cover, multiple use terminal (screw M8)	00	160	38570-0020	3	NSL 3	0,012	0,071	82,00
With terminal and contact cover, V2N-stamped (clamps not attached)	00	160	38575-0600	2	NL 4	0,012	0,105	120,00
Inserted screw nut M12	½	400	38864-0020	1	NL 4	0,018	0,151	133,00
V2N-stamped (Clamps not attached)	½	400	38865-0020	1	NL 4	0,018	0,151	133,00
Inserted screw nut M12	3		38954-0140	1	NL 4			on demand
V2N-stamped (Clamps not attached)	3	630	38955-0020	1	NL 4	0,039	0,263	161,00

NH Fuse-Switches, vertical design and NH Fuse-rails with mounting accessories as complete package
NH Fuse-Switches, vertical design, size 00

Description	Size	Amps	Order-No.	PU	PG	Sur. Ag	Sur. Cu	Price €/pc.
Set connection material for NH Fuse-Switches, vertical design, size 00IN Content: - 1 Set pressure plates with prism 1,5 - 95 mm ² - 3 screws M05 x 30 DIN 302/8,8 - 3 nuts M05 DIN 127	00IN		36239-0020	1	netto			on demand
Set NH Fuse-Switch, vertical design, 3-pole switching, size 00, series 00N with single adapter for 185 mm busbar systems Content: - 1 NH Fuse-Switch, vertical design, 3-pole switching, size 00, series N, with flat terminal - 38500-0000 - 1 Single adapter 100/185 - 36035-0020 - 1 Set Adjusting frame for top and bottom - 36034-0020	00	160	38500-0260	1	netto	0,010	0,075	on demand
Set NH Fuse-Switch, vertical design, 3-pole switching, size 00, series 00N with single adapter for 185 mm busbar systems Content: - 1 NH Fuse-Switch, vertical design, 3-pole switching, size 00, series N, with pressure plates and prism 2,5-70 mm ² - 38502-0000 - 1 Single adapter 100/185 - 36035-0020 - 1 Set Adjusting frame for top and bottom - 36034-0020	00	160	38502-0260	1	netto	0,010	0,075	on demand
Set NH Fuse-Switch, vertical design, 3-pole switching, size 00, series 00IN with single adapter for 185 mm busbar systems Content: - 1 NH Fuse-Switch, vertical design, 3-pole switching, size 00, series IN, multiple use terminal U5 (screws M8) - 38544-0000 - 1 Single adapter 100/185 - 36035-0020 - 1 Set Adjusting frame for top and bottom - 36237-0010	00	160	38544-0260	1	netto	0,013	0,091	on demand

NH Fuse-Switches, vertical design and NH Fuse-Rails

Mounting packet

Description	Size	Amps	Order-No.	PU	PG	Sur. Ag	Sur. Cu	Price €/pc.
Set NH Fuse-Rail, vertical design, size 00, series 00N with single adapter for 185 mm busbar systems Content: - 1 NH Fuse-Rail, vertical design, size 00, series N, with flat terminal - 38550-0000 - 1 Single adapter 100/185 - 36035-0020	00	160	38550-0260	1	netto	0,010	0,075	on demand
Set NH Fuse-Rail, vertical design, size 00, series 00N with single adapter for 185 mm busbar systems Content: - 1 NH Fuse-Rail, vertical design, size 00, series N, flat terminal, with contact- and terminal cover - 38552-0020 - 1 Single adapter 100/185 - 36035-0020	00	160	38552-0260	1	netto	0,010	0,075	on demand
NH Fuse-Switches, vertical desing, size 1								
Set NH Fuse-Switch, vertical design, 1-pole switching, size 1, series 2000, with v-clamps Content: - 1 NH Fuse-Switch, vertical design, 1-pole switching, size 1, series 2000, V-stamped - 38615-0000 - 3 V-clamps 240 mm ² sm -	1	250	38615-0610	1	netto	0,039	0,234	on demand
Set NH Fuse-Switch, vertical design, 3-pole switching, size 1, series 2000, with v-clamps Content: - 1 NH Fuse-Switch, vertical design, 3-pole switching, size 1, series 2000, V-stamped - 38615-0020 - 3 V-clamps 240 mm ² sm	1	250	38615-0990	1	netto	0,039	0,234	on demand
NH Fuse-Switches, vertical desing, size 2								
Set NH Fuse-Switch, vertical design, 3-pole switching, size 2, series 2000, with v-clamps Content: - 1 NH Fuse-Switch, vertical design, 1-pole switching, size 2, series 2000, V-stamped - 38625-00980 - 1 Set V-clamps 2 x 50-185 sm with lug - 36025-0050	2	400	38625-0310	1	netto	0,039	0,234	on demand
Set NH Fuse-Switch, vertical design, 1-pole switching, size 2, series 2000, with v-clamps Content: - 1 NH Fuse-Switch, vertical design, 1-pole switching, size 2, series 2000, V-stamped - 38625-0000 - 3 V-clamps 240 mm ² sm	2	400	38625-0610	1	netto	0,039	0,234	on demand
Set NH Fuse-Switch, vertical design, 3-pole switching, size 2, series 2000, with v-clamps Content: - 1 NH Fuse-Switch, vertical design, 3-pole switching, size 2, series 2000, V-stamped - 38625-0020 - 3 V-clamps 240 mm ² sm	2	400	38625-0990	1	netto	0,039	0,234	on demand
Set NH Fuse-Switch, vertical design, 1-pole switching, size 2 series EKDEO, with v-clamps Content: - 1 NH Fuse-Switch, vertical design, 1-pole switching, size 2, series EKDEO, V-stamped - 38665-0000 - 3 V-clamps 240 mm ² sm	2	400	38665-1180	1	netto	0,018	0,164	on demand
Set NH Fuse-Rail, vertical design, size 2, series EDURO, with v-clamps Content: - 1 NH Fuse-Rail, vertical design, size 2 series EDURO, V2-stamped - 38865-0000 - 3 V-clamps 240 mm ² sm	2	400	38865-1120	1	netto	0,018	0,151	on demand
NH Fuse-Switches, vertical desing, size 3								
Set NH Fuse-Switch, vertical design, 3-pole switching, size 3, series 2000, for paralell operation Content: - 2 NH Fuse-Switch, vertical design, 3-pole switching, size 3, series 2000, with inserted screw nut M12 - 38634-0020 - 1 Connecting frame for paralell operation of 2 NH Fuse-Switches - 45071-0100 - 1 Terminal for paralell switch - 1 Terminal cover for paralell switch	3	1250	38634-1170	1	netto	0,039	0,548	on demand
Set NH Fuse-Switch, vertical design, 3-pole switching, size 3, series 2000, with v-clamps Content: - 1 NH Fuse-Switch, vertical design, 3-pole switching, size 3, series 2000, V-stamped - 38635-00980 - 1 Set V-clamps 2 x 50-185 sm with lug - 36025-0050	3	630	38635-0310	1	netto	0,039	0,264	on demand
Set NH Fuse-Switch, vertical design, 1-pole switching, size 3, series 2000, with v-clamps Content: - 1 NH Fuse-Switch, vertical design, 1-pole switching, size 3, series 2000, V-stamped - 38625-0000 - 3 V-clamps 240 mm ² sm	3	630	38635-0610	1	netto	0,039	0,260	on demand
Set NH Fuse-Switch, vertical design, 3-pole switching, size 3, series 2000, with v-clamps Content: - 1 NH Fuse-Switch, vertical design, 3-pole switching, size 3, series 2000, V-stamped - 38635-0020 - 3 V-clamps 240 mm ² sm	3	630	38635-0990	1	netto	0,039	0,260	on demand
NH Fuse-Rails								
Set NH Fuse-Rail, vertical design, size 3, with v-clamps Content: - 1 NH Fuse-Rail, vertical design, size 3 V2N-stamped - 38955-0020 - 3 V2MD-clamps 240 mm ² sm/rm	3	630	38955-0500	1	netto	0,039	0,268	on demand

NH Fuse-Switches, vertical design and NH Fuse-Rails

Accessories for NH Fuse-Switches, vertical design and Fuse-Rails. size 00

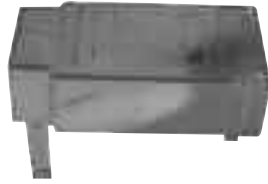

31104-0100

Description	Type	Order-No.	PU	PG	Sur. Ag	Sur. Cu	Price €/pc.
Adapter							
Twin adapter 185/185	00N / 00IN	36035-0010	1	NSL 5			30,95
Mono adapter for the 185 mm busbar system	00N	36035-0020	1	NSL 5		0,089	16,05
Mono-adapter for 60 mm busbar centre distance	00N	36039-0010	1	NSL 5		0,015	14,95
Twin-adapter 185/185		36105-0010	1	NSL 5	0,002	0,080	33,20
Twin-adapter for 185 mm busbar centre distance with side protection	00N / 00IN	36105-0020	1	NSL 5		0,080	38,45
Twin adapter for the 185 mm busbar system	00IN	36235-0010	1	NSL 00IN		0,080	24,55
Mono adapter 100/185 SB	00IN	36035-0050	1	NSL 2			18,15
Connecting material							
V2N-clamp 35 - 240 mm ² sm / 35 - 300 mm ² se (1 Set = 3 pcs.)	00 - 1 - 2 - 3	36148-0010	1	NZ 4			16,05
Terminal connecting set for 2 x M8	00/185	36226-0010	1	NSL 2	0,002	0,008	17,05
MP-Connecting lug	00N 00/185	36125-0010	1	netto			14,90
Pressure plates (1 set = 3 pcs.) for direct connection of cables 1,5 - 25 mm ² or flat cable < 16 x 10 mm	00IN	36238-0010	1	NSL 00IN			4,50
Pressure plates with contact prism (1 set = 3 pcs.) for direct connection of cables 1,5 - 95 mm ²	00IN	36239-0010	1	NSL 00IN			7,70
Pressure plate 1,5 - 25 mm ² (1 Set = 3 pcs.)	00/185	83495-0100	1	NSL 5			3,40
Pressure plate with contact prism 2,5 - 70 mm ² (1 Set = 3 pcs.)	00/185	83496-0100	1	NSL 5			8,80
V-clamp 35 - 70 sm	00/185	85246-0100	1	netto			3,50
Add. terminal cover							
Terminal cover	00N - 00/185	31104-0100	1	NSL 5			1,15
Mounting material							
Contact hooks for mounting without drilling (1 Set = 3 pcs.)	00N / 00IN	36036-0010	1	NSL 5			3,55
Mounting hooks (1 Set = 2 pcs.)	00 1-2-3	36048-0010	1	NSL 5			1,20
Contact hooks for mounting without drilling (1set = 3 pcs.)	00IN	36240-0010	1	NSL 00IN			3,35
Div. covers							
Carrier for identification label	00N	31122-0100	1	NSL 5			1,50
Carrier for identification label for clip-mounting onto housing of the Fuse-Switche	00IN	31568-0100	1	NSL 00IN			1,35
contact cover (1 set = 3 pcs)		36034-0010	1	NSL 5			4,45
Adjusting frame for the length (1 Set = 2 pcs.) by mounting size 00 with size 1-3	00N	36034-0020	1	NSL 5			3,45
Blank panel cover 100 mm width	1-2-3 R2000, NTSL	36102-0020	1	NSL 5			19,20
Blank panel cover 50/185 for twin adapter	00N , 00IN, 00/185	36119-0010	1	NSL 5			14,95
Blank panel cover 50/100 für twin adapter	00N / 00IN	36119-0020	1	NSL 5			14,95
Cover for NH-Lei 00/185	00/185	36130-0010	1	NSL 5			20,30
Side frame	00IN	36236-0010	1	NSL 00IN			4,50
Adjusting frames (1 set = 2 pcs.) to adjust longitudinal difference between NH Fuse-Switches Size 00 and size 1 - 3	00IN	36237-0010	1	NSL 00IN			4,50
Frame for 00N/100	00N	40464-0100	1	NSL 5			4,40
Side frame 00N	00N	40465-0100	1	NSL 5			3,40
Miscellaneous							
Protection from power theft	00IN	31559-0100	1	NSL 00IN			0,80
Nameplate 45 x 17 mm	1-2-3 R2000	36040-0010	1	NSL 5			2,45
Identification label for clip-mounting on carrier or terminal cover	00IN	36233-0010	1	NSL 00IN			2,25
Identification label (with threads) for mounting onto adjusting frames	00IN	36234-0010	1	NSL 00IN			3,30
Micro switch for position indicating	00IN	36252-0010	1	NSL 5			3,40
Electronic fuse monitoring	00IN/00N	36716-0010	1	NSL 00IN			3,90
Micro switch	00/185	85138-0100	1	NT IN 1			6,40
Twining set for parallel operation	00N	31187-0100	1	NSL 5			8,00

NH Fuse-Switches, vertical design and NH Fuse-Rails

Accessories for NH-Fuse-Switches, vertical design, size 1-3

Description	Type	Order-No.	PU	PG	Sur. Ag	Sur. Cu	Price €/pc.
Connecting material							
Insulating cap V2N	1-2-3 R2000, NTSL	31516-0100	1	netto			1,25
Insulating cap V2 MD		31607-0100	1	netto			1,20
PEN connection with lug 2 x 50-185 mm ² sm		36025-0050	1	NZ 4			43,85
35 - 185 mm ² sm, 70 - 240 mm ² se		36025-0060	1	NZ 4			12,30
Claw clamp M12 for 50 - 150 mm ² se (1 Set = 3 pcs.)	1-2-3 R2000, NTSL	36063-0010	1	NZ 4			17,10
PEN connection with lug, V2N-clamp 35 - 240mm ² sm/ 35 - 300mm ² se		36138-0010	1	NZ 4	0,002	0,008	7,80
V2MD-clamp 25-300 mm ²	1-2-3	36298-0010	1	E ³ Zub.			16,05
V2N-clamp 35 - 240 mm ² sm / 35 - 300 mm ² se (1 Set = 3 pcs.)	00 - 1 - 2 - 3	36148-0010	1	NZ 4			16,05
Terminal for parallel switching	1-2-3 R2000	36245-0010	1	NSL 5		0,290	102,00
Add. terminal cover							
Terminal cover 140 mm for V-clamps	1-2-3 R2000, NTSL	31319-0100	1	NSL 5			9,95
Terminal cover 140 mm	1-2-3 R2000, NTS	31319-0200	1	NSL 5			9,60
Contact cover for NH Fuse-Rails	1-2	31605-0100	1	NSL 5			3,00
Terminal cover for parallel switching	1-2-3 R2000	36106-0030	1	NSL 5			28,85
Extension terminal cover for EKDEO	EKDEO	31946-0100	1	netto			7,00
Mounting material							
Mounting hooks (1 Set = 2 pcs.)	00 1-2-3	36048-0010	1	NSL 5			1,20
Contact hooks for EDURO (1 Set = 3 pcs.)	EDURO	36931-0010	1	NZ 3			18,20
Contact hooks for mounting without drilling (1 Set = 3 pcs.)	EKDEO	36932-0010	1	NSL 5			19,25
Div. covers							
Distance bolts for height adjusting (1 Set = 3 pcs.)	1-2-3 R2000	36110-0010	1	NSL 5			23,50
Cover for EDURO	EDURO	36322-0010	1	NSL 2			25,60
Blank panel cover 100 mm width	1-2-3 R2000, NTSL	36102-0020	1	NSL 5			19,20
Side frame	1-2-3 R2000, NTSL	36104-0010	1	NSL 5			14,95
Miscellaneous							
Micro switch for position indicating	1-2-3 R2000	36107-0010	1	NSL 5			5,35
Nameplate 70 x 45 mm	1-2-3 R2000	36133-0010	1	NSL 5			4,45
Micro switch for position indicating	00IN	36252-0010	1	NSL 5			3,40
Carrier for identification label, series EDURO	EDURO	36301-0010	1	netto			5,00
Twinning set for parallel switching of two devices		45071-0100	1	netto			13,45

NH Fuse-Switches, vertical design
and NH Fuse-Rails

Technical data

Technical data for NH Fuse-Switches, vertical design acc. to VDE 0660 / 107 - IEC/EN 60 947-3

For NH Fuse-Links acc. to 0636 T2 1)	Size	00	1	2	3	3 1000A 3)	4a
Rated operational current I_e	A	160	250	400	630	1000	1250/ 1600 2)
Conventional free air thermal current I_{th}	A	160	250	400	630	1000	1250/ 1600 2)
Rated operational voltage U_e	V	690	690	690	690	690	690
Rated insulation voltage U_i	V	800	800	800	800	800	800
Rated impuls withstand voltage	kV	8	8	8	8	8	8
Rated conditional short circuit current (when protected by Fuse-Links) for switches version R2000	kA	50	50 100	50 100	50 100	-	50
Utilization category IEC 60 947-3 Series 2000	$U_e = 400V$ $U_e = 690V$ $U_e = 440V$	AC-22B AC-21B DC-21B	AC-22B AC-21B 4)	AC-22B AC-21B 4)	AC-22B AC-21B 4)	AC-20B AC-20B DC-20B	AC-22B AC-21B DC-21B
Mechanical durability	cycles	1600	1600	1000	1000	1000	600
Permissible ambient air temperature			-25 up to +55 C°				
Type of protection DIN/EN 60 529/VDE 0470 T1	-	IP 2 x					

- Notice:** 1) When using gR-Fuse-Links (VDE 0636/40), please ask for information.
 2) 1600 A possible with Fuse-Links up to a rated power dissipation of 140 W.
 3) Isolator unit with solid copper-links only (on demand).
 4) "DC-Category on demand!"

Tightening torques for terminal and busbar mounting

Size	00	1	2	3	4a
Type of terminal	tightening torques				
Multiple use terminal (screw terminal)	14	32	32	32	M12=32/M16=56
Pressure plates with screws	4	-	-	-	-
Pressure plates with screws and contact prism	4	-	-	-	-
V2N clamp	-	30	30	30	-
V2MD clamp	-	25	25	25	-
Busbar contacting by hooks	-	6	20	20	-

Series 2000

NH Fuse-Switches, vertical design Size 00/100 3-pole switching with a total width of only 50 mm are compact and can be combined ideally with the 100 mm width NH Fuse-Switches sizes 1-3. The clear build-in depth is 190 mm (specification of cable distribution cabinets). They are fully protected against direct contact with live parts in any switch position, acc. to BGV A3. Due to the double breaking per phase (6 arc quenching chambers) the high breaking capacity is achieved. Terminal top or bottom is optional without modification.

The variety of useful accessories of the NH Fuse-Switches size 00/100 offer an all-round application. For example contacting on busbars of 60 mm, 100 mm and 185 mm busbar centre distances is possible.

NH Fuse-Switches, vertical design, size 00: 125/160 A, 3-pole switching, for busbars with 100 mm centre distance

Description/Terminal	Size	Amps I _n	Order no.	Description	Pack	Weight in kg
Screw terminal M8	00N	160 ¹⁾	38500-0000	NH-La-Lei 00N G4	2	1,19
Pressure plate for 1,5 - 50mm ²	00N	125 ²⁾	38501-0000	NH-La-Lei 00N U3	2	1,17
Pressure plate with contact prism für 2,5-70mm ²	00N	160 ³⁾	38502-0000	NH-La-Lei 00N U4	2	1,21

Other types on demand.

- 1) Cable terminal 50 n (125 A). Flat terminal 20 mm width (160 A).
- 2) Conductor cross section 1,5–25 mm²
- 3) Conductor cross section 2,5–70 mm²



Screw terminal
38500-0000



Pressure plate
38501-0000



Pressure plate with contact prism
38502-0000

Accessories of NH Fuse-Switches, vertical design, size 00: 125/160 A, 3-pole switching, for busbars with 100 mm centre distance

Description	Terminal	Order no.	Description	Pack	Weight in kg
Carrier for identification label	00N	31122-0100	INFOTRÄGER NH-LA-LEI 00N	1	0,01
Contact hooks (for mounting without drilling) (1 set = 3 pcs.)	00N, 00/185	36036-0010	1 SATZ KONTAKTHAKEN	1	0,08
Frame 00N/100	00N	40464-0100	BLENDRAHMEN GR.00N/100	1	0,10
Side frame 00N	00N	40465-0100	BLENDSTREIFEN GR.00N	1	0,10
Adjusting frame for the length (1 Set = 2 pcs.) by mounting size 00 with size 1-3	00N	36034-0020	1 SATZ AUSGLEICHSBLENDE	1	0,06
Nameplate (with thread) 45 x 17 mm	00-3	36040-0010	BEZEICHNUNGSSCHILD SCHRAUBBAR	1	0,01
MP-Connecting lug	00N 00/185	36125-0010	MP-DOPPELANSCHLUSSSCHIENE	1	0,10
Blank panel cover 50/100 for twin adapter	00N	36119-0020	LEERFELDABDECKUNG 50/100	1	0,10
Connecting frame for twin version	00N	31187-0100	VERBINDUNGSBLEND LA-LEI 00N	1	0,05

Carrier for identification label
31122-0100



Contact hooks (for mounting without drilling)
36036-0010



Adjusting frame
36034-0020



Nameplate (with thread)
36040-0010



MP-Connecting lug
36125-0010

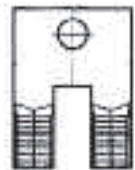

NH Fuse-Switches, vertical design, size 00IN, 3-pole switching

Description	Size	Amps I _n	Order no.	Description	Pack	Weight in kg
Multiple use terminal (screw M8) Directmounting on 60 mm busbar systems with hooks, terminal top	00	160	38534-5000	NH-LA-LEI 00IN 3P O 60 U5	2	1,265
Multiple use terminal (screw M8) Directmounting on 60 mm busbar systems with hooks, terminal bottom	00	160	38534-1000	NH-LA-LEI 00IN 3P U 60 U5	2	1,27
Multiple use terminal (screw M8), direct mounting on 100 mm busbar systems, cable terminal top/bottom selection possible	00	160	38544-0000	NH-LA-LEI 00IN 3P U5	2	1,155

Size 00, Order no.: 38544-0000

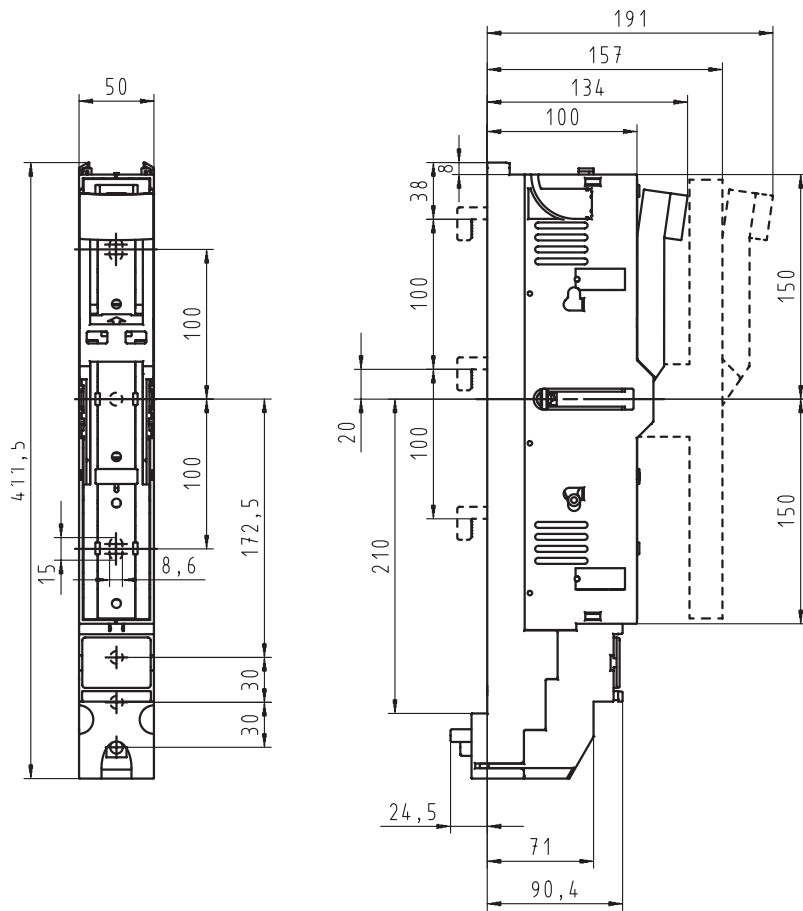

Size 00, Order no.: 38534-1000

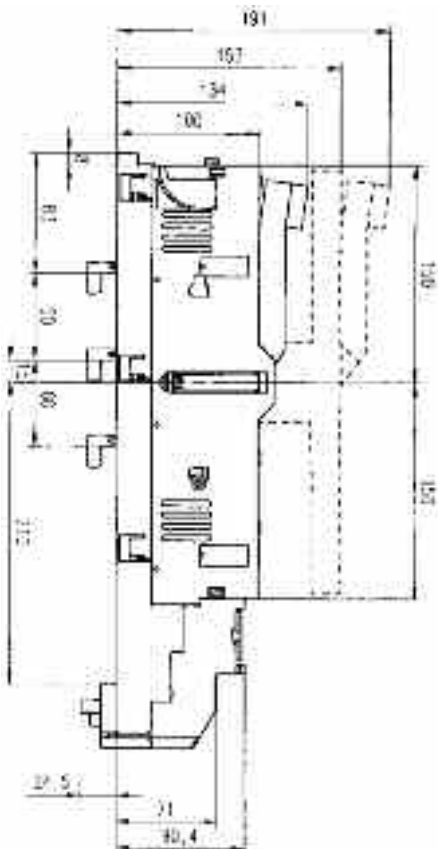

NSL/NL

NH Fuse-Switches size 00/185, single pole switchable

are in their vertical width of 50 mm ideal comparable with the 100 mm NH Fuse-Switch size 1-3. The standard conditional shock protection according to BGV A3 is met in either way, switch-on or switch-off position. Through the special spacious cable service area

and the possibility to disconnect each phase separately, these fuses are exquisitely operational for fitting into the cable terminal boxes, or into the low-voltage distribution net of the energy supply system.

NH Fuse-Switches, vertical design, size 00: 160 A, 1-pole switching, for busbars with 185 mm centre distance

Description	Size	Amps I _n	Order no.	Description	Pack	Weight in kg
Multiple use terminal (screw M8)	00/185	160	38520-0000	NH-La-Lei 00/185 1P U5	2	2,22
V2N-terminal includes the V-clamp 35-240 sm/35-300 se	00/185	160	38525-0600	NH-La-Lei 00/185 1P VK V2N	2	2,79

Terminal

Multiple use terminal (screw M8)
38520-0000



V2N-terminal
38525-0600

Accessories for NH Fuse-Switches, vertical design, size 00: 160 A, 1-pole switching, for busbars with 185 mm centre distance

Description	Size	Order no.	Description	Pack	Weight in kg
Carrier for identification label	00	31122-0100	INFOTRÄGER NH-LA-LEI 00N	1	0,01
Contact hooks (for mounting without drilling) / (1 set = 3 pcs.)	00N, 00/185	36036-0010	1 SATZ KONTAKTHAKEN	1	0,08
Nameplate (with thread) 45 x 17 mm	00-3	36040-0010	BEZEICHNUNGSSCHILD SCHRAUBBAR	1	0,01
Mounting hooks (1 set = 2 pcs.)		36048-0010	MONTAGEHAKEN 1 SATZ		
Pressure plate 1,5-25 mm ² (1 set = 3 pcs.)	00/185	83495-0100	DRUCKSTÜCKE GR.00/185 1 SATZ	1	0,10
Pressure plate with contact prism 2,5 - 70 mm ² (1 set = 3 pcs.)	00/185	83496-0100	KONTAKTPRISMEN GR.00/185 1 SATZ	1	0,10
Microswitch	00/185	85138-0100	MIKROSCHALTER TYP 1	1	0,00
PEN connecting lug	00N 00/185	36125-0010	MP-DOPPELANSCHLUSSSCHIEBE	1	0,10
V-clamp 35 - 70 sm	00/185	85246-0100	KLEMME 35-70 SM	1	0,04
Terminal connection set for 2 x M8	00/185	36226-0010	T-STÜCK 00/185	1	0,25
Blank panel cover 50/185 for twin adapter	00/185	36119-0010	LEERFELDDABDECKUNG 50/185	1	0,10
Connecting frame for twin version	00N	31187-0100	VERBINDUNGSBLEND LA-LEI 00N	1	0,05

Carrier for identification label
31122-0100

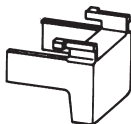

Contact hooks
36036-0010

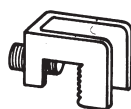

Nameplate
36040-0010

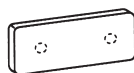

Carrier for identification label
36246-0010

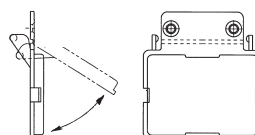

Mounting hooks
36048-0010



Pressure plate 1,5-25 mm²
83495-0100



Pressure plate with contact prism 2,5 - 70 mm² re/rm/se/sm
83496-0100



PEN connecting lug
36125-0010



V-clamp 35 - 70 sm mm² sm for Terminal connection set
36125-0010

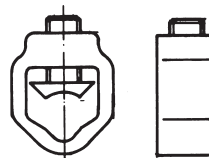

NH Fuse-Switch, vertical design, size 00/185: 160 A

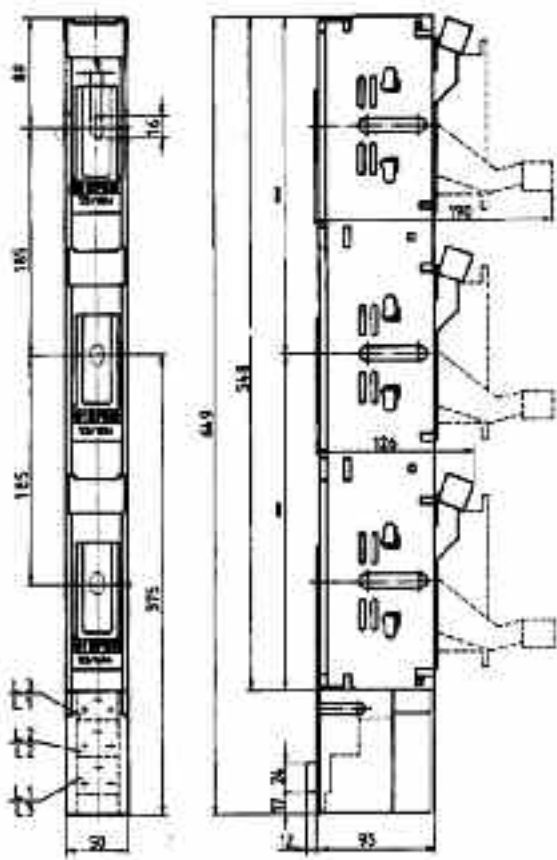

Busbar adapter
for NH Fuse-Rails / NH Fuse-Switches, size 00/100

NH Fuse-rails size 00/100 and NH Fuse-Switches, vertical design, size 00/100 are basically designed for busbars with a 100 mm busbar centre distance. They can be either fixed with screws or without drilling by means of contacting hooks.

By use of special adapters, these units are also suitable for busbars

with centre distances of 60 mm or 185 mm.

Thus the normal standard range of busbar systems of NH Fuse-Bases, 3-pole, vertical design, size 00/100 mounted on busbars is covered. The adapter for 185 mm busbar distance adjusts the height difference to NH Fuse-Switches, vertical design, sizes 1 – 2 – 3, the additionally available adjusting frames level the length difference.

Busbar adapter size 00/100 and 00/185

Description	Size	Order no.	Description	Pack	Weight in kg
Mono-adapter for 60 mm busbar centre distance	00N	36039-0010	EINFACHADAPTER 100/60	1	0,28
Twin-adapter for 185 mm busbar centre distance with side protection	00N	36105-0020	DOPPELADAPTER 100/185 BG	1	1,00
Mono adapter for the 185 mm busbar system	00N, 00IN	36035-0020	EINFACHADAPTER 100/185	1	0,47
Twin-adapter 185/185	00/185	36105-0010	DOPPELADAPTER 185/185	1	0,10
Twin adapter 100/185	00N / 00IN	36035-0010	DOPPELADAPTER 100/185	1	0,29
Twin adapter 100/185	00N / 00IN	36235-0010	DOPPELADAPTER LA-LEI 00IN 100/185	1	1,00

Busbar adapter 100/60 mm

Mono-adapter for 60 mm busbar-system
Order-no. 36039.0010

max.

the middle symmetric application is secured when using a 50 mm busbar-system with an adaptor application

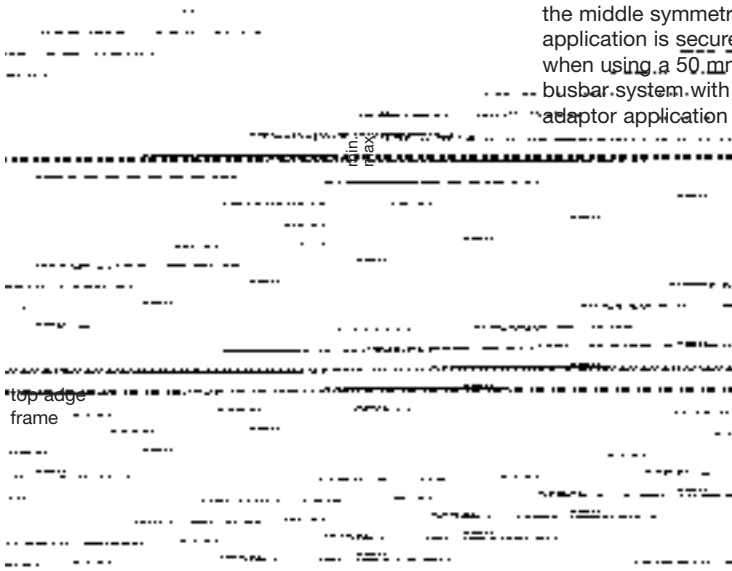

Busbar adapter 185/185 mm

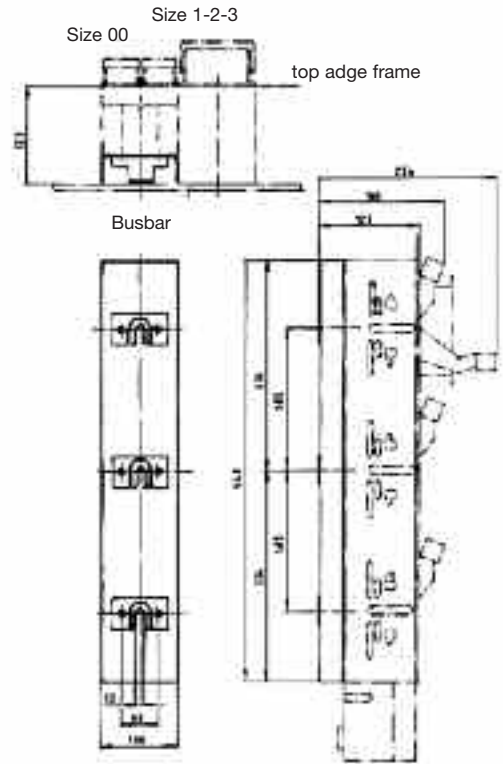

Busbar adapter 100/185 mm

Size 1-2-3

Size 00

top edge frame

Busbar



NSL/NL

NH Fuse-Switches size 1–3 series 2000

are usable for busbar systems 185 mm and have in all other model types the same vertical dimensions of 100 mm. This makes it possible to obtain a uniform layout in the switchboard. With the parallel guidance of the NH Fuse-Links a double speed is achieved and the high breaking capacity can be reached. After activating the vario-key to turn-off position the product can be put into a secure pad lock position. This is most convenient through the new spacious free floating mechanism. In either on- or off position, the switch control can be secured through key locks against an unauthorized turn-on.

The NH Fuse-Switches vertical design size 1–3 series 2000 offer a variable selection of cable terminal on either top or bottom. A protection against direct contact according to BGV A3 is given in all operating positions. Assembly hooks make it possible to place fuse switch on upper busbar were assembling under current is easier and safer. All insulating material is self extinguishing, halogen free and extremely heat resistant.

NH Fuse-Switches size 1N: 250 A

Description/Terminal	Size	Amps I _n	Type	Order no.	Description	Pack	Weight in kg
Inserted screw nut M12	1	250	single pole switching	38614-0000	NH-La-Lei 1N 1P S6	1	5,92
Inserted screw nut M12	1	250	three pole switching	38614-0020	NH-La-Lei 1N 3P S6	1	5,76
Threaded bolt M12 x 30	1	250	single pole switching	38612-0000	NH-La-Lei 1N 1P B6	1	4,50
Threaded bolt M12 x 30	1	250	three pole switching	38612-0020	NH-La-Lei 1N 3P B6	1	5,81
V-stamped ¹⁾	1	250	single pole switching	38615-0000	NH-La-Lei 1N 1P V2	1	5,75
V-stamped ¹⁾	1	250	three pole switching	38615-0020	NH-La-Lei 1N 3P V2	1	5,58

NH Fuse-Switches size 2N: 400 A

Description/Terminal	Size	Amps I _n	Type	Order no.	Description	Pack	Weight in kg
Inserted screw nut M12	2	400	single pole switching	38624-0000	NH-La-Lei 2N 1P S6	1	5,89
Inserted screw nut M12	2	400	three pole switching	38624-0020	NH-La-Lei 2N 3P S6	1	5,75
Threaded bolt M12 x 30	2	400	single pole switching	38622-0000	NH-La-Lei 2N 1P B6	1	5,92
Threaded bolt M12 x 30	2	400	three pole switching	38622-0020	NH-La-Lei 2N 3P B6	1	5,83
V-stamped ¹⁾	2	400	single pole switching	38625-0000	NH-La-Lei 2N 1P V2	1	5,68
V-stamped ¹⁾	2	400	three pole switching	38625-0020	NH-La-Lei 2N 3P V2	1	5,54

NH Fuse-Switches size 3N: 630 A

Description/Terminal	Size	Amps I _n	Type	Order no.	Description	Pack	Weight in kg
Inserted screw nut M12	3	630	single pole switching	38634-0000	NH-La-Lei 3N 1P S6	1	6,14
Inserted screw nut M12	3	630	three pole switching	38634-0020	NH-La-Lei 3N 3P S6	1	5,97
Threaded bolt M12 x 30	3	630	single pole switching	38632-0000	NH-La-Lei 3N 1P B6	1	6,18
Threaded bolt M12 x 30	3	630	three pole switching	38632-0020	NH-La-Lei 3N 3P B6	1	5,99
V-stamped ¹⁾	3	630	single pole switching	38635-0000	NH-La-Lei 3N 1P V2	1	5,91
V-stamped ¹⁾	3	630	three pole switching	38635-0020	NH-La-Lei 3N 3P V2	1	5,78

¹⁾ For connecting terminals see Accessories

Inserted screw nut M12



Threaded bolt M12



V-stamped



Single pole switching

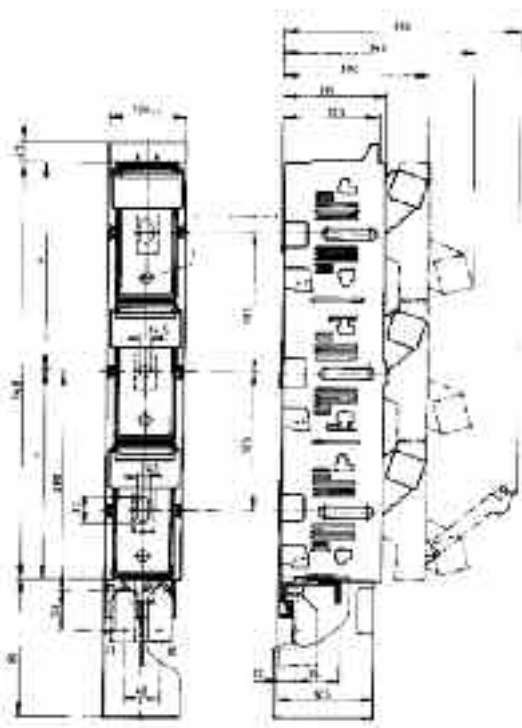

Terminal	Dim. a
Inserted screw nut M12	180
V-stamped ¹⁾	140

Three pole switching

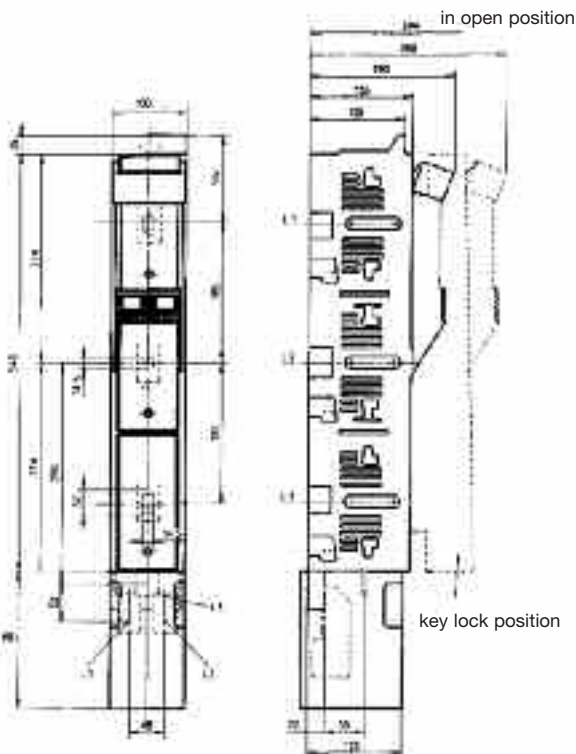

Terminal	Dim. a
Inserted screw nut M12	180
V-stamped ¹⁾	140

NH Fuse-Switches size 3, 1-pole or 3-pole switching, series 2000 as 1000 A-Incoming-Switch

The NH-Switch 100 A is used as an incoming unit for busbar systems, when no protection with NH fuses, instead only a breaking point is requested. The switches will be delivered with special solid links 1000 A with a low power dissipation.

After activation the vario-key to turn-of-position the switch can be put in a secure pad log position. The switch can be secured through key logs against an unauthorized operating.

NH-Switches 1000 A

Description/Terminal	Size	Amps I _n	Type	Order no.	Description	Pack	Weight in kg
Inserted screw nut M12, top/bottom	3	1000	single pole switching	38634-0260	NH-Tr-Lei 3N 1P 1000A S6	1	7,00
Inserted screw nut M12, top/bottom	3	1000	three pole switching	38634-0250	NH-Tr-Lei 3N 3P 1000A S6	1	7,25
M12 - Terminal back side	3	1000	single pole switching	38630-0530	NH-Tr-Lei 3N 1PH 1000A L6	1	5,97
M12 - Terminal back side	3	1000	three pole switching	38630-0540	NH-Tr-Lei 3N 3PH 1000A L6	1	7,00
M12 - sidewise branch connection	3	1000	single pole switching	38630-0140	NH-Tr-Lei 3N 1PL/R 1000A L6	1	5,99
M12 - sidewise branch connection	3	1000	three pole switching	38630-0150	NH-Tr-Lei 3N 3PL/R 1000A L6	1	5,84

top/bottom back connection

window: red

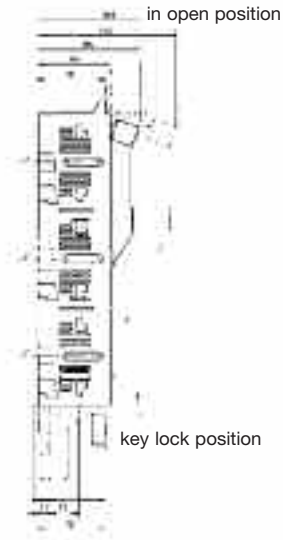
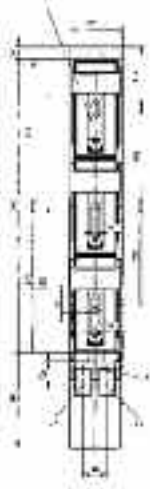

rear back connection

window: red

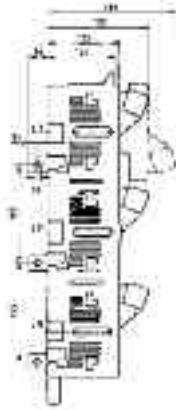
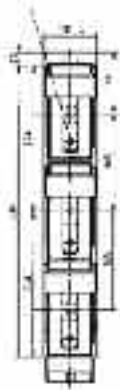

sidewise back connection

window: red

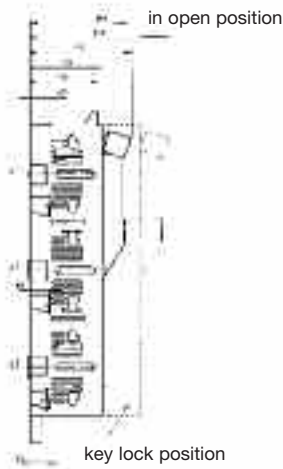

NH Fuse-Switches series 2000
vertical design, for horizontal mounting

The NH Fuse-Switches series 2000, vertical design size 00 are also in standard version suitable for horizontal mounting. The NH Fuse-Switches, vertical design, sizes 1 – 2 – 3 are special types and suitable for horizontal mounting as special types, are suited for horizontal mounting.

NH Fuse-Switches for horizontal mounting

Description/Terminal	Size	Amps I _n	Type	Order no.	Description	Pack	Weight in kg
Inserted screw nut M12	1	250	single pole switching	38614-0180	NH-La-Lei 1N 1P WA S6	1	4,50
Inserted screw nut M12	1	250	three pole switching	38614-0170	NH-La-Lei 1N 3P WA S6	1	5,77
Inserted screw nut M12	2	400	single pole switching	38624-0180	NH-La-Lei 2N 1P WA S6	1	4,50
Inserted screw nut M12	2	400	three pole switching	38624-0170	NH-La-Lei 2N 3P WA S6	1	5,74
Inserted screw nut M12	3	630	single pole switching	38634-0180	NH-La-Lei 3N 1P WA S6	1	7,00
Inserted screw nut M12	3	630	three pole switching	38634-0170	NH-La-Lei 3N 3P WA S6	1	5,95

NH Fuse-Switches series 2000
vertical design, with sidewise back connection
NH Fuse-Switches with sidewise back connection

Description/Terminal	Size	Amps I _n	Type	Order no.	Description	Pack	Weight in kg
Screw terminal M12, right/left	2	400	single pole switching	38620-0120	NH-La-Lei 2N 1PL/R L6	1	4,50
Screw terminal M12, right/left	3	630	single pole switching	38630-0120	NH-La-Lei 3N 1PL/R L6	1	5,09
Screw terminal M12, right/left	2	400	three pole switching	38620-0130	NH-La-Lei 2N 3PL/R L6	1	4,50
Screw terminal M12, right/left	3	630	three pole switching	38630-0130	NH-La-Lei 3N 3PL/R L6	1	4,49

NH Fuse-Switches, vertical design, size 1 – 2 – 3

are constructed of uniform basic elements and vary only in their dimensions depending on the amperages resp. measurements of NH Fuse-Links. Switching is optional 1-pole or 3-pole and a cable connection at top or bottom is available. By parallel disconnecting of the NH Fuse-Links out of the switch contacts, the high breaking

capacity is achieved. An unintentional contact of live parts even in an open switch position is not possible. Many different versions as well as practical accessories give an optimum of applications to the user.

NH Fuse-Switches, vertical design, size 1: 125 A

Description/Terminal	Size	Amps I _n	Type	Order no.	Description	Pack	Weight in kg
Screw terminal M10, bottom	1	250	single pole switching	38100-0005	NH-La-Lei 1 1PU GGL5	1	4,50
Screw terminal M10, top	1	250	single pole switching	38150-0005	NH-La-Lei 1 1PO GGL5	1	4,50
Screw terminal M10, bottom	1	250	three pole switching	38100-0025	NH-La-Lei 1 3PU GGL5	1	6,76
Screw terminal M10, top	1	250	three pole switching	38150-0025	NH-La-Lei 1 3PO GGL5	1	6,66

NH Fuse-Switches, size 2: 400 A

Description/Terminal	Size	Amps I _n	Type	Order no.	Description	Pack	Weight in kg
Screw terminal M10, bottom	2	400	single pole switching	38200-0005	NH-La-Lei 2 1PU GGL5	1	4,50
Screw terminal M10, top	2	400	single pole switching	38250-0005	NH-La-Lei 2 1PO GGL5	1	4,50
Screw terminal M10, bottom	2	400	three pole switching	38200-0025	NH-La-Lei 2 3PU GGL5	1	6,76
Screw terminal M10, top	2	400	three pole switching	38250-0025	NH-La-Lei 2 3PO GGL5	1	6,76

1) Other types on demand.

Terminal	Dim. a
Inserted screw nut M12	180
Threaded bolt M12	180
Screw terminal M10	180
V-stamped ¹⁾	140

NH Fuse-Switch, vertical design, size 1: 250 A

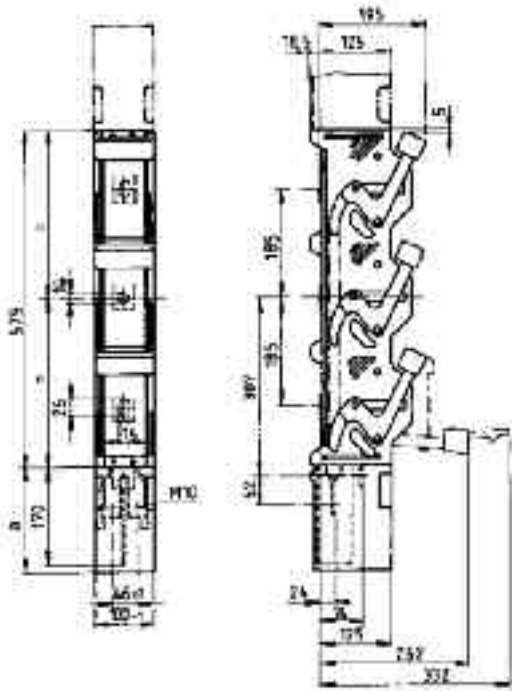

NH Fuse-Switch, vertical design, size 2: 400 A

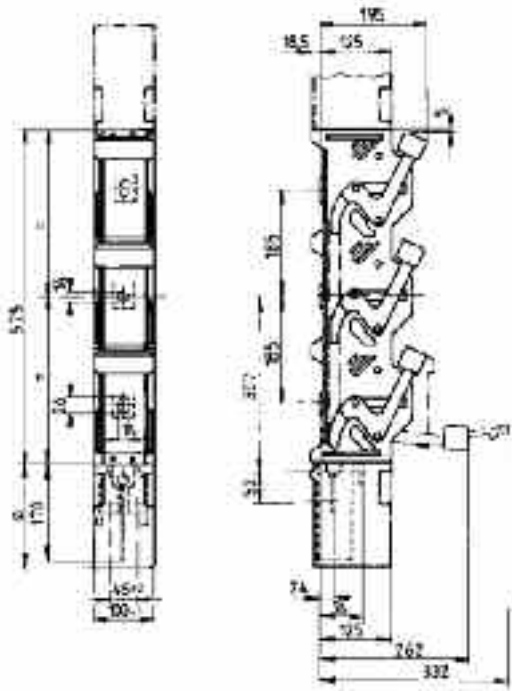

NSL/NL

NH Fuse-Switch size 3: 630 A

Description/Terminal	Size	Amps I _n	Type	Order no.	Description	Pack	Weight in kg
Inserted screw nut M12, bottom	3	630	single pole switching	38300-0005	NH-La-Lei 3 1PU GGL6	1	7,00
Inserted screw nut M12, top	3	630	single pole switching	38350-0005	NH-La-Lei 3 1PO GGL6	1	7,22
Inserted screw nut M12, bottom	3	630	three pole switching	38300-0025	NH-La-Lei 3 3PU GGL6	1	7,52
Inserted screw nut M12, top	3	630	three pole switching	38350-0025	NH-La-Lei 3 3PO GGL6	1	7,49

Other types on demand.

NH Fuse-Switch, vertical design, size 4a: 1250/1600 A

Description/Terminal	Size	Amps I _n	Type	Order no.	Description	Pack	Weight in kg
Inserted screw nut M16, bottom	4a	1250 ¹⁾	single pole switching	38400-0000	NH-La-Lei 4a 1PU L8	1	16,71
Inserted screw nut M16, top	4a	1250 ¹⁾	single pole switching	38450-0000	NH-La-Lei 4a 1PO L8	1	16,40
Inserted screw nut 2 x M12, bottom	4a	1600 ¹⁾	single pole switching	38400-0020	NH-La-Lei 4a 1PU 1600 A L6	1	19,00
Inserted screw nut 2 x M12, top	4a	1600 ¹⁾	single pole switching	38450-0020	NH-La-Lei 4a 1PO 1600 A L6	1	19,00

¹⁾ Other types on demand.

1600 A possible with Fuse-Links up to a rated power dissipation of 140 W.

When several units of size 4a have to be installed side-by-side, the distance between has to respect the dimensions of connecting parts.

M16

2 x M12



NH Fuse-Switches, vertical design, with coupling a system

These versions have been designed to connect two busbar systems of 185 mm centre distance.

NH Fuse-Switches with coupling system

Description	Size	Amps I _n	Type	Order no.	Description	Pack	Weight in kg
coupling system, connecting behind	3	630	single pole switching	38630-0560	NH-LA-LEI 3N 3P KL1	1	7,00
coupling system, connecting in front	3	630	single pole switching	38630-0590	NH-LA-LEI 3N 3P KL2	1	5,04
coupling system, terminal on the right side behind	4a	1250	single pole switching	38400-0260	NH-La-Lei 4a 1P KL1	1	19,00

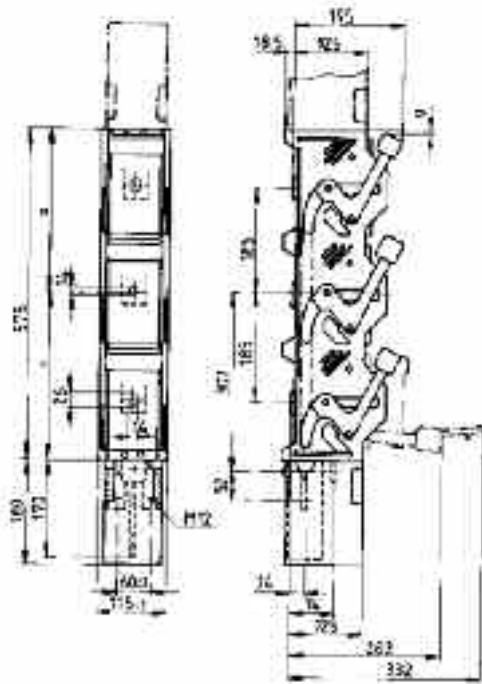
NH Fuse-Switch, vertical design, size 3: 630 A



NH Fuse-Switch, vertical design, size 4a: 1250/1600 A

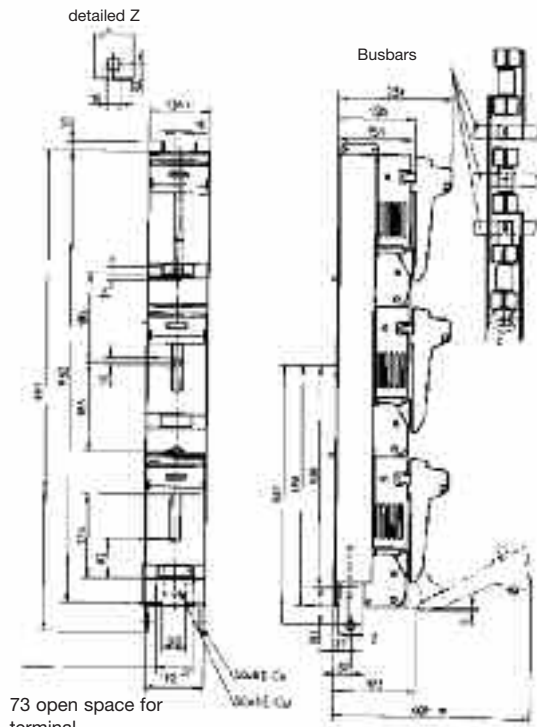

73 open space for terminal

* for removal of lid 425 mm is assential

NH Fuse-Switch, size 3, 3-pole switching, with coupling system

KL1

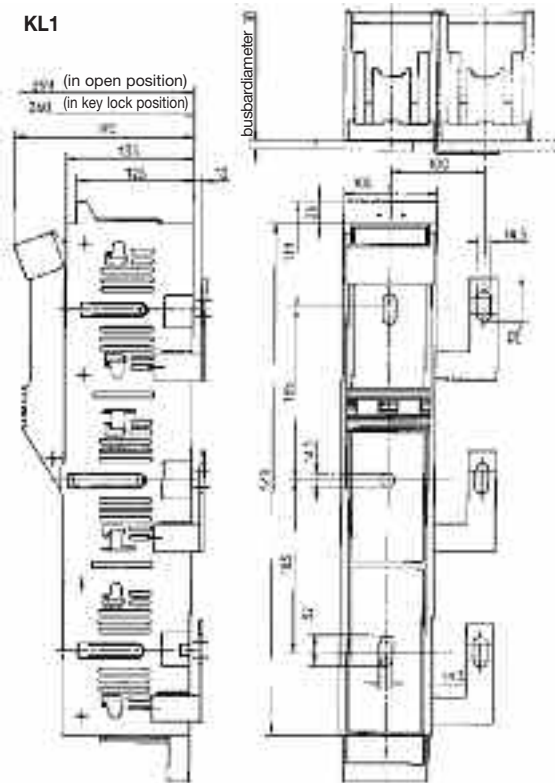

KL2

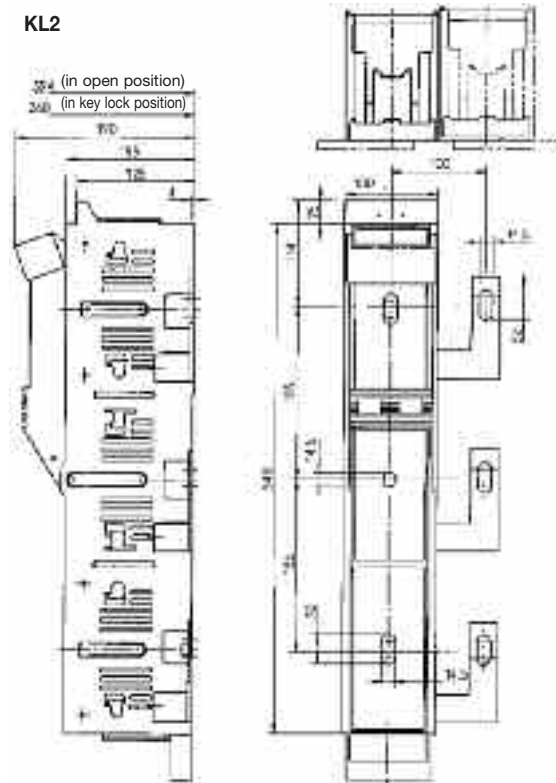

**NH Fuse-Switch, vertical design, size 4a: 1250 A
with coupling system**

Contact angle to be made by customer

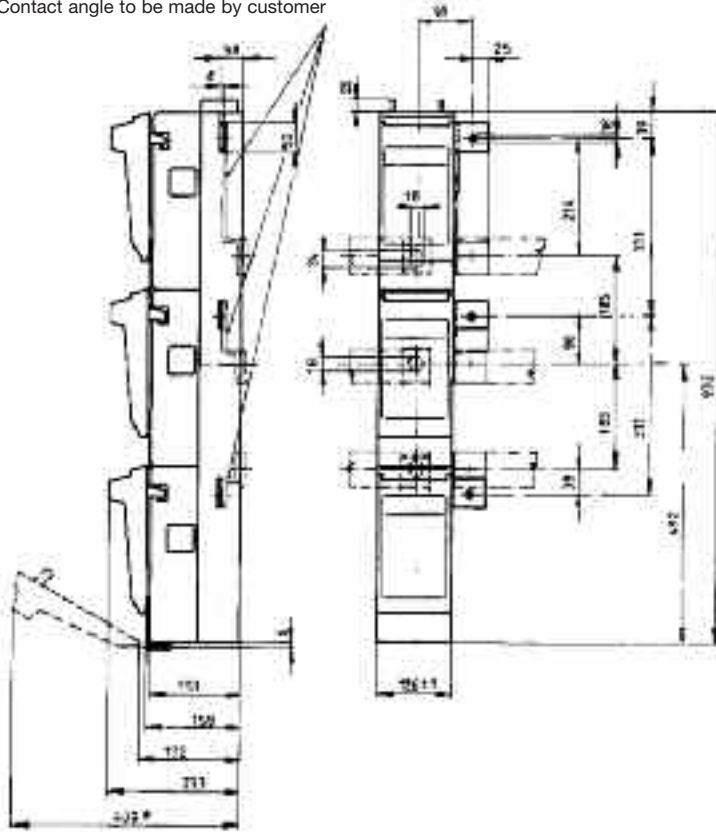

NH Fuse-Switches, vertical design, size 1 - 3, series 2000 with contact hooks

- Direct busbar mounting without drilling for 5-10 mm busbars
- Busbars width up to 120 mm
- Fast assembly and adjustment under voltage
- Hooks are pre-assembled for terminal side on bottom
- Hooks could be easily changed for terminal side on top

NH Fuse-Switches Size 1: 250 A

Description	Size	Amps I _n	Type	Order no.	Description	Pack	Weight in kg
Screw terminal M12	1	250	1-pole	38614-1230	NH-La-Lei 1N 1P Bh S6	1	4,50
Screw terminal M12	1	250	3-pole	38614-1240	NH-La-Lei 1N 3P Bh S6	1	6,25
Threaded bolt M12x30	1	250	1-pole	38612-1230	NH-La-Lei 1N 1P Bh B6	1	4,50
Threaded bolt M12x30	1	250	3-pole	38612-1240	NH-La-Lei 1N 3P Bh B6	1	4,50
V-stamped ¹⁾	1	250	1-pole	38615-1230	NH-La-Lei 1N 1P Bh V2	1	4,50
V-stamped ¹⁾	1	250	3-pole	38615-1240	NH-La-Lei 1N 3P Bh V2	1	4,50

NH Fuse-Switches Size 2: 400 A

Description	Size	Amps I _n	Type	Order no.	Description	Pack	Weight in kg
Screw terminal M12	2	400	1-pole	38624-1230	NH-La-Lei 2N 1P Bh S6	1	4,50
Screw terminal M12	2	400	3-pole	38624-1240	NH-La-Lei 2N 3P Bh S6	1	4,50
Threaded bolt M12x30	2	400	1-pole	38622-1230	NH-La-Lei 2N 1P Bh B6	1	4,50
Threaded bolt M12x30	2	400	3-pole	38622-1240	NH-La-Lei 2N 3P Bh B6	1	4,50
V-stamped ¹⁾	2	400	1-pole	38625-1230	NH-La-Lei 2N 1P Bh V2	1	4,50
V-stamped ¹⁾	2	400	3-pole	38625-1240	NH-La-Lei 2N 3P Bh V2	1	4,50

NH Fuse-Switches Size 3: 630 A

Description	Size	Amps I _n	Type	Order no.	Description	Pack	Weight in kg
Screw terminal M12	3	630	1-pole	38634-1230	NH-La-Lei 3N 1P Bh S6	1	7,00
Screw terminal M12	3	630	3-pole	38634-1240	NH-La-Lei 3N 3P Bh S6	1	7,00
Threaded bolt M12x30	3	630	1-pole	38632-1230	NH-La-Lei 3N 1P Bh B6	1	7,00
Threaded bolt M12x30	3	630	3-pole	38632-1240	NH-La-Lei 3N 3P Bh B6	1	7,00
V-stamped ¹⁾	3	630	1-pole	38635-1230	NH-La-Lei 3N 1P Bh V2	1	7,00
V-stamped ¹⁾	3	630	3-pole	38635-1240	NH-La-Lei 3N 3P Bh V2	1	7,00

¹⁾ without clamps, for order clamps see chapter **NZ**

NH Fuse-Switches, vertical design for 630 kVA applications.

Please contact us for the technical documentation.

Special features are:

- rated power 630 kVA by AC 400 V
- robust construction and thermally high pressure plastic structure material
- extreme switching value thru parallel disconnection
- connections variable with exit on top or at bottom and also on the back side.

Available as well is the 630 kVA fuse switch size 3.

Description/Terminal	Size	kVA	Type	Order no.	Description	Pack	Weight in kg
M12, bottom	3	630	single pole switching	38300-1235	NH-La-Lei 3 1PU 630kVA VE SM ST GG L6	1	5,60
M12, top	3	630	single pole switching	38350-1235	NH-La-Lei 3 1PO 630kVA VE SM ST GG L6	1	7,12
Inserted screw M12, back side	3	630	single pole switching	37374-1465	NH-La-Lei 3 1PH 630kVA GG S6	1	7,00
M12, bottom	3	630	three pole switching	38300-1275	NH-La-Lei 3 3PU 630kVA VE SM ST GG L6	1	7,29
M12, top	3	630	three pole switching	38350-1275	NH-La-Lei 3 3PO 630kVA VE SM ST GG L6	1	7,32
Inserted screw M12, back side	3	630	three pole switching	38374-1495	NH-La-Lei 3 3PH 630kVA GG S6	1	7,00

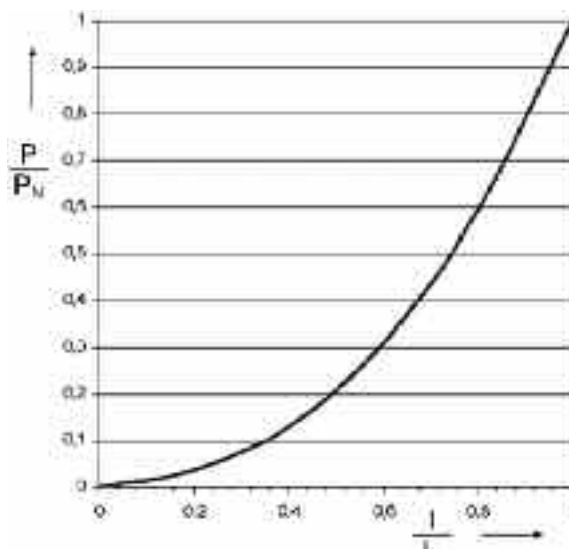
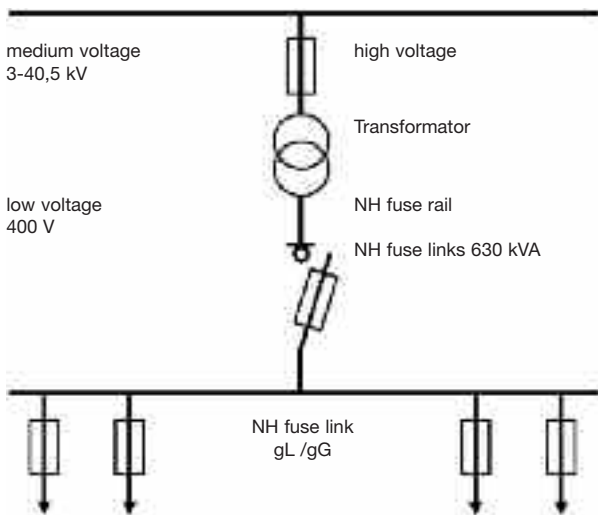

630 kVA NH Incoming-Fuse-Switch-Disconnecter with special terminal block

Utilisation:

As incoming Fuse-Switch in low-voltage distribution - panels of transformer stations up to 630 kVA.

Advantages:

Terminal for busbars up to 60 mm width by usage of special terminals

Avoidance of crossings between cables or busbars to secondary contacts of transformers due to mirrored terminals L1/L3

Easy design and guaranteed compliance with prescribed air and creepage distances by fixed distances between the phases.

High electro dynamical stability due the extremely strong contact terminals. Reliable thermal operating safety at alternating ambient conditions due to increased width of Fuse-Switch-Disconnecter of 115mm.

Description	Size	kVA	Type	Order no.	Description	Pack	Weight in kg
Special terminal for busbar 60 mm, 3-pole switching, terminal top	3	630	three pole switching	38350-1595	NH-LA-LEI 3 3PO 630KVA SV L8 (L6)	1	7,00

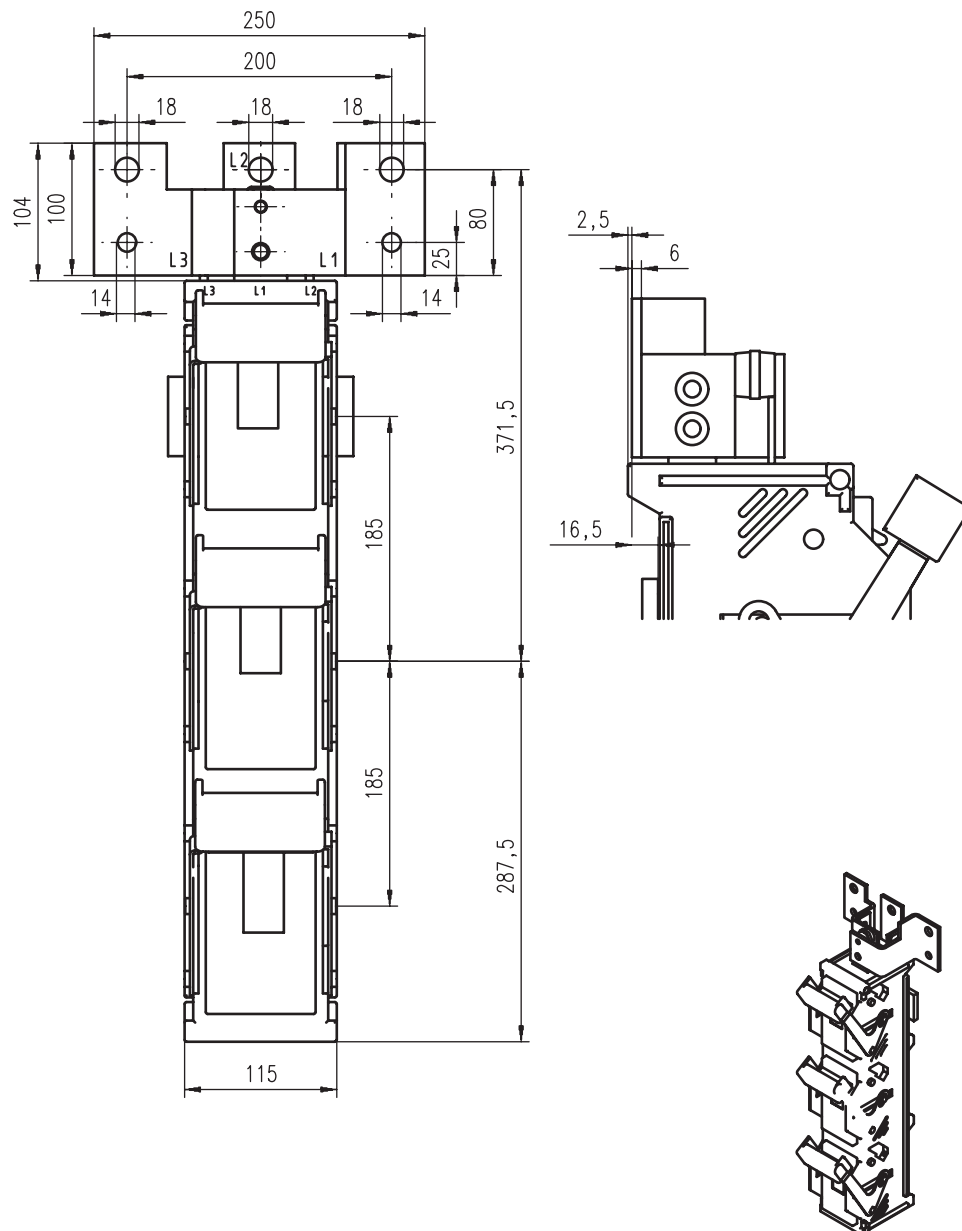

NSL/NL

NH Fuse-Switches size 1/2, 1-pole switching, series EKDEO

NH Fuse-Switches, series EKDEO offers a lot of specific features for the power supply business.

- Easy voltage test directly on the contact knife of the NH fuse-link.
- Easy Current measurement

- Insertion of a pickupack-Fuse-Switch
- Working with earthing cartridge
- 150 mm installation depth for extremely flat cabinets

Technical Data acc. VDE 0660 T107 / IEC/EN 60947-3

For NH Fuse-Links acc. VDE 0636 T 201	Size	2	
Rated operational current I_e^*	A	400	
Conventional free air thermic current I_{th}	A	400	
Rated operational voltage U_e	V	690	
Rated insulation voltage U_i	V	1000	
Rated impuls withstand voltage U_{imp}	kV	12	
Rated conditional short circuit current (when protected by NH Fuse-Links)	kA	100	
Utilization category VDE 0660 T107 / EN / IEC 60947-3	$U_e=400$ V AC $U_e=500$ V AC $U_e=690$ V AC $U_e=440$ V DC	AC-23B AC-22B AC-21B DC-21B	
Mechanical durability	Cycles	1600	
Rated duty	Uninterrupted duty		
Permissible ambient temperature	°C	-25 up to +55	
Degree of protection DIN/EN 60529 / VDE 0470 T1	IP	2x	
Tightening torque (recommend)	Busbar	Busbar connecting	32 Nm
		Hook connecting	20 Nm
	Cable connection	Terminal screw M12	32 Nm
		V2N-clamp	30 Nm
	V2 MD-Clamp	25 Nm	
Maximum power dissipation of the NH Fuse-Links	Pv max.	34 W	

* When using gR-Fuse-links (VDE 0636/40) in our NH Switches please ask for information. Engineering progress is a continuous process for us. All information and data may therefore be changed without notification.

NH Fuse-Switches size 2, 1-pole switching, series EKDEO

Description	Size	Amps I_n	Order no.	Description	Pack	Weight in kg
Inserted screw nut M12	2	400	38664-0000	EKDEO 2 1P S6	1	3,77
Threaded bolt M12x30	2	400	38662-0000	EKDEO 2 1P B6	1	3,77
V-stamped (Clamps not attached)	2	400	38665-0000	EKDEO 2 1P V2	1	3,77
V2N-stamped (Clamps not attached)	2	400	38665-0470	EKDEO 2 1P V2N	1	3,77

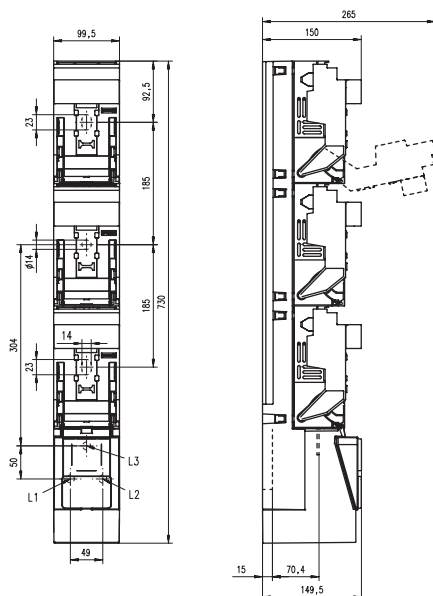

CT-Adapter kit for outgoing terminal of NH Fuse-Switch-Rail

A continuous measurement of the operational currents needs an arrangement of current transformers in each outgoing line. In most cases the ct's are mounted between busbars and the switches.

With the kit you have the solution.

- Ideal for all application with-out space for ct's between busbar and switch.
- Cable connection with cable lug direct on current transformer
- Easy access to current transformers and readability of type plate without removal of the switch.
- Re-fitting to all standard Fuse-Switches, vertical design, size 1-3, series 2000 with inserted screw nut.
- Very easy access enabled change of ct's without removal of the NH Fuse-Switch and without de-energizing of substation.

CT-Adapter kit for outgoing terminal of NH Fuse-Switch, vertical design

Description	Size	Amps I _n	Type	Order no.	Description	Pack	Weight in kg
Adapter kit current transformers for NSL 1-3 / series 2000, incl. long terminal cover	1-3			36324-0010	Wandleranbau an NH-LA-LEI 1-3N	1	2,00

Special connecting devices

- Safety contacting of -2 x 240 mm²
- 3 x 150 mm²
- Free access to connecting terminals
- High stability also during short circuit
- Low transition resistances
- Flexible application by convenient accessory package
- Protection against touch by extended terminal cover

Special connecting devices for NH Fuse-Switches vertical design

Description	Size	Amps I _n	Type	Order no.	Description	Pack	Weight in kg
Connecting unit 2 x 240 mm ² for series NTSL and 2000	1-3		Connecting parts for L1, L2 and L3, 6 pcs. screws M12 + washers	36302-0010	ANSCHLUSSEINHEIT 2X240 FÜR NTSL U. R2000	1	2,30
Connecting unit 3 x 150 mm ² for series 2000	1-3		Connecting parts for L1, L2 and L3, 9 pcs. screws M12 + washer and 9 pcs. cable lugs 12-150mm ²	36289-0010	ANSCHLUSSEINHEIT 3X150 NUR FÜR R2000	1	2,30
Terminal cover 280 mm length	1-3		-	82076-0100	ANSCHLUSSRAUMAB-DECKUNG AK10	1	0,15

Electronic Fuse-Monitoring - Size 00

- According IEC /EN 60 255
DIN VDE 0435-303
For AC 380 – 415 V
- Useable for all NH Fuse-Switches vertical design size 00 and all types of fuses
- Mounting of the Fuse-Monitoring separately on a supporting rail
- Short-circuit-proof cable connection (2,5 mm²) of all phases from fuse-monitoring to the busbar, also to the outgoing cable terminals of the Fuse-Switch vertical design
- Contacting with 6 plugs, suitable or M8. Connection of the cables using flat plugs 6,3 mm.
- 2 LED-indicators to control the actually state of the fuses

Electronic Fuse-Monitoring for NH Fuse-Switches vertical design - Size 00

Description	Size	Amps I _n	Type	Order no.	Description	Pack	Weight in kg
Electronic Fuse-Monitoring	00			36716-0010	ESÜ FÜR NH-LA-LEI 00	1	0,6

Fuse-monitoring in 3-phase-network

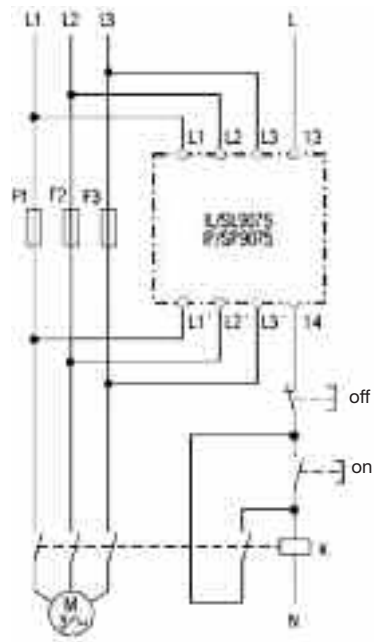

Fuse-monitoring in AC-network



NH Fuse-Rails, sizes 00 - 3 acc. to IEC 60269 - 2

are protected against accidental access to live parts by means contact covers acc. BGV A3. All insulating parts are made of halogen-free, flame retardant polymer have excellent high temperature performance.

NH Fuse-Rails, size 00 - 3, with contact- and terminal cover

Description	Size	Amps I _n	Order no.	Description	Pack	Weight in kg
With terminal and contact cover, Flat terminal M8 (screw M8)	00	160	38550-0020	NH-LEI 00N SH G4	1	0,74
With terminal and contact cover, Multiple use terminal (screw M8)	00	160	38570-0020	NH-LEI 00/185 SH U5	3	1,42
With terminal and contact cover, V2N-stamped (clamps not attached)	00	160	38575-0600	NH-LEI 00/185 SH VK V2N	2	1,97
Inserted screw nut M12, Type EDURO	½	400	38864-0020	NH-LEI 1-2 SH S6	1	2,41
V2N-stamped (Clamps not attached), Type EDURO	½	400	38865-0020	NH-LEI 1-2 SH V2N	1	2,22
Inserted screw nut M12	3	630	38954-0020	NH-LEI 3N SH S6		
V2N-stamped (Clamps not attached)	3	630	38955-0020	NH-LEI 3N SH V2N	1	5,00

Accessories for NH Fuse-Switches
and Fuse-Rails, vertical design, size 00

Technical data

Description	Type	Order no.	Description	Pack	Weight in kg
Adapter					
Twin adapter 100/185	00IN/00N	36035-0010	DOPPELADAPTER 100/185	1	0,80
Mono adapter for the 185 mm busbar system	00IN/00N	36035-0020	EINFACHADAPTER 100/185	1	0,47
Mono-adapter for 60 mm busbar centre distance	00N	36039-0010	EINFACHADAPTER 100/60	1	0,28
Twin adapter 185/185	00/185	36105-0010		1	
Twin-adapter for 185 mm busbar centre distance with side protection	00N	36105-0020	DOPPELADAPTER 100/185 BG	1	1,00
Twin adapter for the 185 mm busbar system	00IN	36235-0010	DOPPELADAPTER LA-LEI 00IN 100/185	1	1,00
Mono adapter 100/185 SB	00IN	36035-0050	EINFACHADAPTER 100/185 SB		0,29
Connecting material					
V2N-clamp 35-240 sm / 35-300 se	00-1-2-3	36148-0010	1 SATZ KLEMME V2N 240SM	1	0,10
Terminal connecting set for 2 x M8	00/185	36226-0010	T-STÜCK 00/185	1	0,25
MP-Connecting lug	00N, 00/185	36125-0010	MP-DOPPELANSCHLUSSSCHIENE	1	0,10
Pressure plates (1 set = 3 pcs.) for direct connection of cables 1,5 - 25 mm ² or flat cable < 16 x 10 mm	00IN	36238-0010	DRUCKSTÜCKE LA-LEI 00IN	1	0,10
Pressure plates with contact prism (1 set = 3 pcs.) for direct connection of cables 1,5 - 95 mm ²	00IN	36239-0010	DRUCKSTÜCKE U. PRISMEN LA-LEI 00IN	1	0,10
Pressure plate 1,5 - 25 mm ² (1 Set = 3 pcs.)	00/185	83495-0100	DRUCKSTÜCKE GR.00/185 1 SATZ	1	0,10
Pressure plate with contact prism 2,5 - 70 mm ² (1 Set = 3 pcs.)	00/185	83496-0100	KONTAKTPRISMEN GR.00/185 1 SATZ	1	0,10
V-clamp 35 - 70 sm	00/185	85246-0100	KLEMME 35-70 SM	1	0,04
Add. terminal cover					
Terminal cover	00N - 00/185	31104-0100	ANSCHLUSSRAUMABDECKUNG	EFEN1	0,01
Mounting material					
Contact hooks (for mounting without drilling) (1 set = 3 pieces)	00N, 00/185	36036-0010	1 SATZ KONTAKTHAKEN	1	0,08
Mounting hooks (1 Set = 2 pieces)	00IN, Reihe 2000	36048-0010	MONTAGEHAKEN 1 SATZ	1	0,01
Contact hooks (1 set = 3 pcs.) for mounting without drilling on busbars	00IN	36240-0010	HAKEN LA-LEI 00IN	1	0,05
Div. covers					
Carrier for identification label	00N	31122-0100	INFOTRÄGER NH-LA-LEI 00N	1	0,01
Carrier for identification label for clip-mounting onto housing of the Fuse-Switch Size 00	00IN	31568-0100	INFOTRÄGER LA-LEI 00IN	1	0,01
Contact cover (1 Set = 3 pairs)	00N	36034-0010	1 SATZ KONTAKTABDECKUNG NH-LEI 00N		
Adjusting frames (1 set = 2 pcs.) to adjust longitudinal difference between NH Fuse-Switches size 00 and size 1 - 3	00N	36034-0020	1 SATZ AUSGLEICHSBLENDE	1	0,06
Blank panel cover 100 mm width	1-2-3 R2000, NTSL	36102-0020	LEERFELDABDECKUNG 100/185	1	0,10
Blank panel cover 50/185 for twin adapter	00/185	36119-0010	LEERFELDABDECKUNG 50/185	1	0,10
Blank panel cover 50/100 für twin adapter	00N	36119-0020	LEERFELDABDECKUNG 50/100	1	0,10
Cover for NH-Lei 00/185	00/185	36130-0010	ABDECKUNG LEI 00/185	1	
Side frame	00IN	36236-0010	BLENDSTREIFEN NH-LA-LEI 00IN	1	0,10
Adjusting frames (1 set = 2 pcs.) to adjust longitudinal difference between NH Fuse-Switches Size 00 and size 1 - 3	00IN	36237-0010	AUSGLEICHSBLENDE LA-LEI 00IN	1	0,05
Frame for 00N/100	00N	40464-0100	BLENDRAHMEN GR.00N/100	1	0,10
Side frame 00N	00N	40465-0100	BLENDSTREIFEN GR.00N	1	0,10
Miscellaneous					
Protection from power theft	00IN	31559-0100	STROMDIEBSTAHLSICHERUNG LA-LEI 00IN	1	0,01
Nameplate (with threads) 45 x 17 mm	00N, 00IN, 00/185, R2000, NTSL,	36040-0010	BEZEICHNUNGSSCHILD SCHRAUBBAR	1	0,01
Identification label for clip-mounting on carrier or terminal cover	00IN	36233-0010	BEZEICHNUNGSSCHILD LA-LEI 00IN	1	0,05
Identification label (with threads) for mounting onto adjusting frames	00IN	36234-0010	BEZEICHNUNGSSCHILD LA-LEI 00IN SCHRAUBB.	1	0,05
Micro switch for position indicating electronic fuse monitoring	00IN, EKDEO	36252-0010	MIKROSCHALTER NH-LA-LEI 00IN	1	0,01
Micro switch	00N, 00IN	36716-0010	ESÜ FÜR NH-LA-LEI 00	1	0,01
Micro switch	00/185	85138-0100	MIKROSCHALTER TYP 1	1	0,01
Twinning set for parallel operation	00N	31187-0100	VERBINDUNGSBLEND LA-LEI 00N	1	0,05

Accessories for NH Fuse-Switches and Fuse-Rails, vertical design, size 1- 3

Technical data

Description	Type	Order no.	Description	Pack	Weight in kg
Connecting material					
Insulating cap V2N	V2N	31516-0100	ISOLIERKAPPE V2N	1	0,01
Insulating cap V2 MD	V2 MD	31607-0100	ISOLIERKAPPE V2 MD	1	0,01
V2N-clamp 2 x 50-185 ² sm/2 x 70-240 ² se	1-2-3	36025-0050	1 SATZ V-KLEMME 2X 50-185 SM MIT LASCHE	1	
V-clamp 35-185 ² sm/50-240 ² se	V	36025-0060	1 SATZ V-KLEMME 35-185 SM V2	1	0,23
Claw clamp M12 for 1 set (3 pieces) M12 for 50 - 150 mm ² se	1-2-3 R2000, NTSL	36063-0010	ANSCHLUSSKLEMMEN 50-150 SE FÜR S6 1 SATZ	1	0,29
PEN connection with lug, V2N-clamp 35-240 mm ² sm / 35-300		36138-0010	MP-ANSCHLUSSEINHEIT V2N 240 SM	1	0,10
V2 MD-clamp 35-240 / 35-300 se	V2 MD	36298-0010	1 SATZ KLEMMEN V2 MD 240SM/RM	1	0,35
V2N-clamp 35-240 sm / 35-300 se	00-1-2-3	36148-0010	1 SATZ KLEMME V2N 240SM	1	0,10
Terminal for parallel switching	R2000	36245-0010	ANSCHLUSSGARNITUR ZWILLINGSLEI-STE EFEN	1	0,20
Add. terminal cover					
Terminal cover 140 mm for V-clamps	1-2-3 R2000, NTSL	31319-0100	ANSCHLUSSRAUMABDECKUNG AK6	1	0,10
Terminal cover 140 mm	1-2-3 R2000, NTSL	31319-0200	ANSCHLUSSRAUMABDECKUNG AK3	1	0,15
Terminal-cover for NH Fuse-Switches	EDURO	31605-0100	ANSCHLUSSRAUMABDECKUNG LEI 1-2	1	0,01
Terminal cover for parallel switch	1-2-3 R2000	36106-0030	ANSCHLUSSRAUMABDECKUNG	1	0,10
Extension terminal cover for EKDEO	EKDEO	31946-0100	ANSCHLUSSRAUMABDECKUNG LA-LEI 1/2 EVU	1	0,10
Mounting material					
Mounting hooks (1 Set = 2 pieces)	00IN, Reihe 2000	36048-0010	MONTAGEHAKEN 1 SATZ	1	0,01
Contact hook (for busbar without drilling) 1 set = 3 pieces	EDURO	36931-0010	1 SATZ KONTAKTHAKEN EDURO	1	0,01
Contact hook (for busbar without drilling) 1 set = 3 pieces	EKDEO	36932-0010	1 SATZ KONTAKTHAKEN EKDEO	1	0,01
Div. covers					
Distance bolts for height adjusting by the blank bar cover (1 Set = 3 pcs.)	1-2-3 R2000, NTSL	36110-0010	1 SATZ DISTANZSTÜCKE M12	1	0,10
Cover for NH Fuse-Switches	EDURO	36322-0010	ABDECKUNG LEI 1-2 EDURO	1	0,10
Blank panel cover 100 mm width	1-2-3 R2000, NTSL	36102-0020	LEERFELDABDECKUNG 100/185	1	0,10
Side frame	1-2-3 R2000, NTSL	36104-0010	1 SATZ BLENDSTREIFEN LA-LEI 1-3N	1	0,10
Miscellaneous					
Micro switch for position indicating	1-2-3 R2000	36107-0010	MIKROSCHALTER FÜR SCHALTZUSTANDSANZEIGE	1	0,10
Nameplate 70 x 45 mm	1-2-3 R2000	36133-0010	BEZEICHNUNGSSCHILD LA-LEI 1-3N	1	0,01
Mikroschalter zur Schaltstellungsanzeige	00IN, EKDEO	36252-0010	MIKROSCHALTER NH-LA-LEI 00IN	1	0,01
Carrier for identification label	EDURO	36301-0010	INFOTRÄGER LEI 1-2	1	0,01
Twinning set for parallel operation	R2000	45071-0100	VERBINDUNGSBLENDE LA-LEI 1-3N	1	

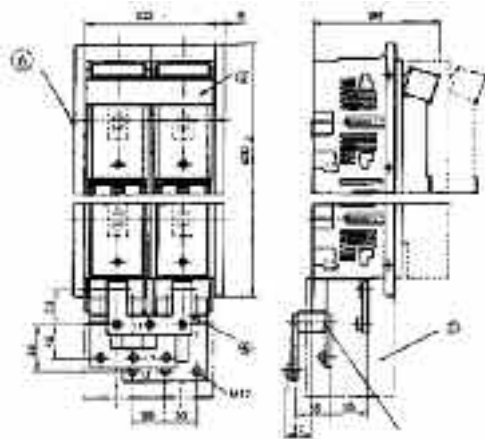

Terminal possibilities for each phase 3 cable lug 12-240

removal of the impress nut on the terminal rail

- ③ **Connectingframe**
45071-0100
- ④ **Terminal for parallel switch**
36245-0010
- ⑤ **Terminal cover for parallel switch**
36106-0030
- ⑥ **side frame**
36104.0010

NH Fuse-Switches
and Fuse-Rails, vertical design

Technical data

NH Fuse-Switches and Fuse-Rails, vertical design, size 00
Accessories

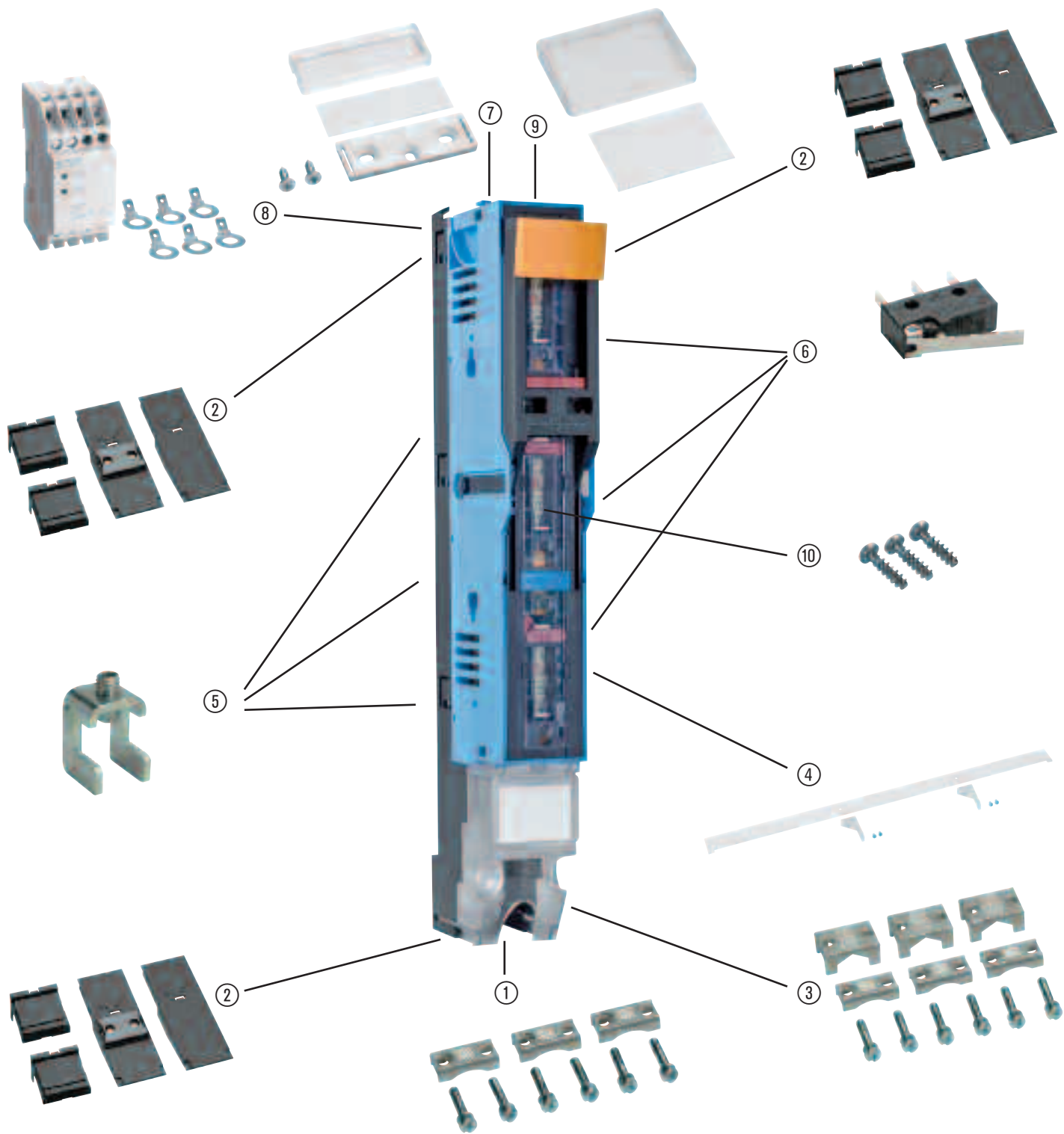

- ① 36238-0010 Pressure plates LA-LEI 00IN
- ② 36237-0010 Adjusting frames LA-LEI 00IN
- ③ 36239-0010 Pressure plates with contact prism LA-LEI 00IN
- ④ 36236-0010 Side frame NH-LA-LEI 00IN
- ⑤ 36240-0010 Contact hooks LA-LEI 00IN
- ⑥ 36252-0010 Micro switch NH-LA-LEI 00IN
- ⑦ 36040-0010 Nameplate
- ⑧ 36716-0010 Electronic fuse monitoring for NH-LA-LEI 00

- ⑨ 36233-0010 Identification label LA-LEI 00IN
- ⑩ 31559-0010 Protection from power theft LA-LEI 00IN

NH Fuse-Switches and Fuse-Rails, vertical design, size 1- 3
Accessories

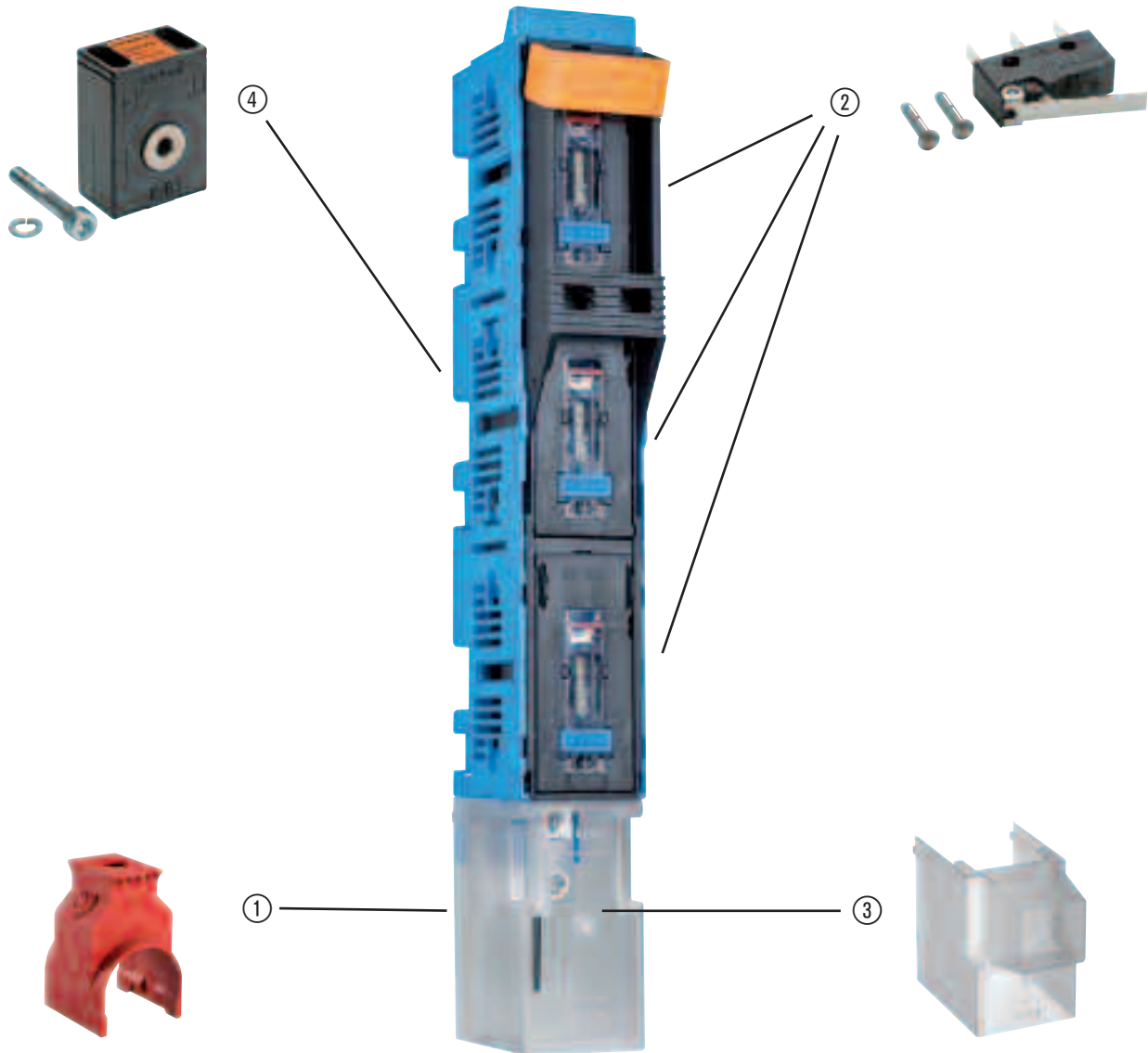

- ① 31607-0100 Insulating cap V2 MD
- ② 36107-0010/2 Micro switch for position indicating
- ③ 31319-0100 Terminal cover AK3
- ④ Clip-on Current Transformers, see chapter NW

Accessories
for NH Fuse-Switches and Fuse-Rails

Technical data

V2N-/V2MD clamp for 25–300 mm² range

By using the V2N-/V2MD clamp combination a new wide range can be covered. The V2N-clamp is compatible with the traditional V-stamped terminal and offers the possibility of connecting a cable-cross-section from 70 – 300 mm². By using the device with a modified V-stamped terminal version (V2N) the clamp area will extend to 25–300 mm².

Description	Cross section 1)	Order no.
Clamp V2N (1 set = 3 pcs.)	25-150 rm ①	36148-0010
	25-185 re ②	
	35-240 sm ③	
	35-300 se ③	
Insulating cap	-	31516-0100

Description	Cross section 1)	Order no.
Clamp V2 MD (1 set = 3 pcs.)	25-240 rm	36298-0010
	25-240 re	
	35-240 sm	
	35-300 se	
Insulating cap	-	31607-0100

1) This cross section is only possible when using switches with special V-shaped terminal.

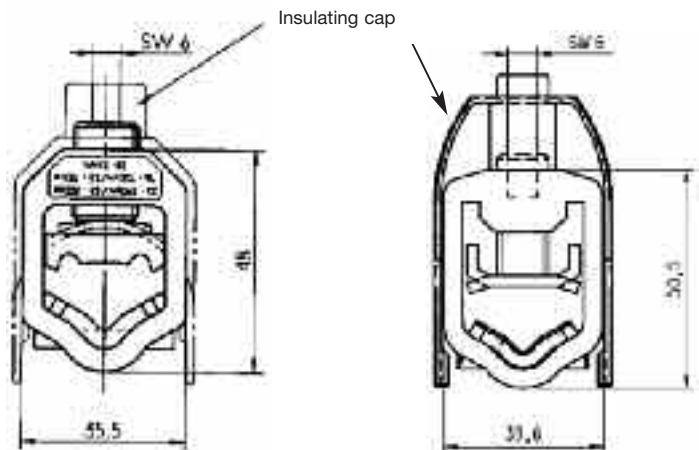
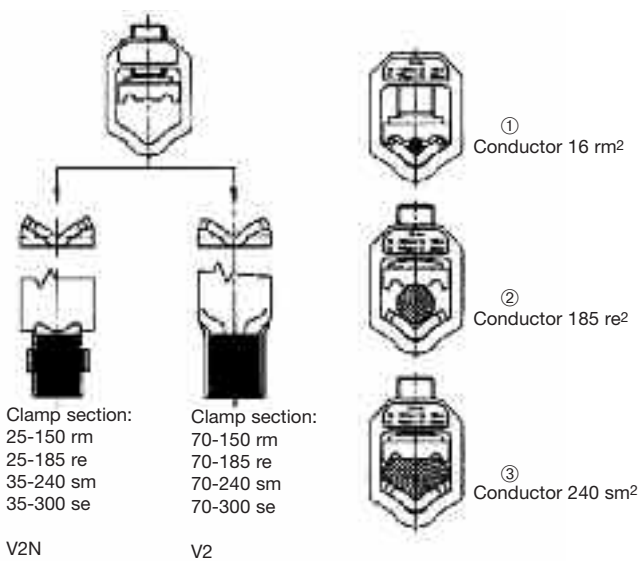

Accessories
for NH Fuse-Switches and Fuse-Rails

Technical data

V-clamp
36025-0060



V2N-clamp
36148-0010



V2MD-clamp
36298-0010



Claw clamp
36063-0010



Terminal cover R2000
31319-0100



Terminal cover R2000
31319-0200



Terminal cover 00N and 00/185
31104-0100



Terminal cover
31334-0100



Terminal cover EKDEO
31605-0100

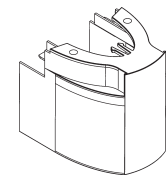

Cover for NH-Lei 1-2
36322-0010



Cover for NH-Lei 00/185
36130-0010



Contact cover
36034-0010



Blank panel cover
36102-0020

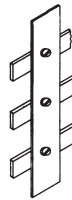

Nameplate NTSL
36151-0010

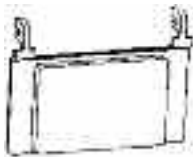

Nameplate
36040-0010



Nameplate
36065-0010



Nameplate R2000
36133-0010

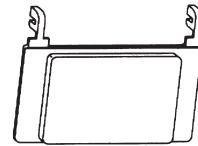

Contact hook
36036-0010



Mounting hooks
36048-0010



Carrier for identification label
36301-0010

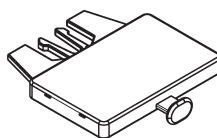

NSL/NL